

PANTM

BIO TECH



The Catalogue!



www.pan-biotech.com



**We don't simply sell products.
We offer solutions!**

Products

- ✓ Serum
- ✓ Serum-free Media
- ✓ Serum Replacement
- ✓ Classic Media
- ✓ Reagents
- ✓ Supplements

Services

- ✓ Cell & Media Development
- ✓ Customer Media Production
(Liquid & Powder)
- ✓ OEM Production/
Contract Manufacturing
- ✓ Rapid Response Production
- ✓ Customized Packaging

Dear valued Customer

PAN-Biotech is a modern and innovative company with headquarters in Aidenbach / Germany. The company was founded in 1988, expanded its business and set up its own research and production facilities in the following years to finally reach its actual size. Today, PAN-Biotech is a major producer of biotechnological products, which are distributed worldwide and used for scientific research at universities and pharmaceutical companies as well as for production purposes in the biopharmaceutical industry. The company develops and produces a wide range of innovative biotechnological products for all areas of cell culture, including serum- and protein-free media, bovine sera (FBS and others) from different countries of origin including special variants and a broad variety of classical and special media for cell culture.

Over the last three decades we have grown into an internationally accepted and appreciated supplier for the life science industry. Still though we remain - as one of a few - a privately owned, ownership managed company. This reflects in our values: With us you get personal attention and full engagement when you need assistance, no matter whether you are from academic research or industry.

Combined with our advanced manufacturing and quality-control systems and our flexibility as a medium sized company this is what makes us who we are: a trusted partner for successful cell culture.

At this point we would like to say “Thank you” to our customers, suppliers, partners and staff for enabling - **30 years PAN-Biotech.**

Rapid Product Search can be performed by

- Examining the table of contents shown at the beginning of this catalogue
- Studying the individual chapter index page
- Using the alphabetical index shown at the end of this catalogue

Our website www.pan-biotech.com has an extended search function enabling you to find all available products, product information, various protocols, certificate of analysis.

Should you have any further questions than please feel free to contact our customer service.

Please note additional information

- **Footnotes:** Products with red coloured footnotes are either usually on stock, the minimum order is 20 pieces or are available upon request as the following example illustrates (**example 1**).

Example 1:

Bovine Serum Albumin (BSA) Low Endotoxin ⁽¹⁾	10 g	P60-139310
	50 g	P60-139350

- (1) usually on stock
- (2) minimum order 20 pieces
- (3) available upon request

- **Notes below tables:** Below some table are additional information to certain products marked with a star * (shown in **example 2**)

Example 2:

Fetal Bovine Serum Biotech, Australia origin, tested acc. EMEA 1793 and Ph. Eur. 2262*	100 ml	P40-1301
	500 ml	P40-1302

* tested upon request and produced after receipt of order

Supplements of liquid media

Liquid media from PAN-Biotech do not include antibiotics, serum supplements and often none L-Glutamine as well.

This refers to the increase of the retention period and gives media more flexible application possibilities.

Should L-Glutamine be necessary, we recommend to use the 200 mM solution.

Liquid media	Adding L-Glutamine solution (200 mM) ml/L
BME EBSS	10.0
BME HBSS	10.0
DMEM	20.0
DMEM/F-12	12.5
Glasgow MEM	10.0
IMDM	20.0
L-15	10.25
McCoy's 5A	7.5
M-199 EBSS	3.4
M-199 HBSS	3.4
MEM	10.0
Ham's F10	5.0
Ham's F12	5.0
RPMI-1640	10.25

SEE PAGE 11

FBS MSC



FBS MSC
 Fetal Bovine Serum tested for MSCs
 Quality attributes verified
 Tested according to ENX 1793
 and EN 12255
 sterile filtered
 Cat. No.: P04-0111
 Lot No.: various
 Volume: 100 ml
 Store at: -20 °C
 Expiry: various
 for cell culture
PAN BIOTECH

SEE PAGE 28

Panexin basic



Panexin basic
 Serum Replacement
 with Defined Components
 sterile filtered
 Cat. No.: P04-0500
 Lot No.: various
 Volume: 100 ml
 Store at: -20 °C
 Expiry: various
 for cell culture
PAN BIOTECH

SEE PAGE 23

Human Platelet Lysate



Human Platelet Lysate
 w/α: heparin, podofil
 sterile filtered
 Cat. No.: P40-20050
 Lot No.: various
 Volume: 50 ml
 Store at: -20 °C
 Expiry: various
 for cell culture
PAN BIOTECH

SEE PAGE 130

Growth Factors



SEE PAGE 56

PowerStem MSC1



PowerStem MSC1
 Serum-free Basal Medium
 for Human Mesenchymal Stem Cells
 (hMSCs)
 w/ soluble Glutamine
 sterile filtered
 Cat. No.: P04-710613
 Lot No.: various
 Volume: 50 ml
 Store at: -20 °C
 Expiry: various
 for cell culture
PAN BIOTECH

SEE PAGE 127

Bovine Serum Albumin



Bovine Serum Albumin (BSA)
 30% Solution
 low salt
 sterile filtered
 Cat. No.: P04-05110
 Lot No.: various
 Volume: 100 ml
 Store at: 2-8 °C
 Expiry: various
PAN BIOTECH

SEE PAGE 39

Panserin ProVero



Panserin ProVero
 Complete Medium
 for Vero Cells
 w: L-Glutamine
 sterile filtered
 Cat. No.: P04-710613
 Lot No.: various
 Volume: 500 ml
 Store at: 2-8 °C
 Expiry: various
 for cell culture
PAN BIOTECH

SEE PAGE 152

Industrial Services



1	Sera	8 - 23	5	Biologicals	128 - 133
	Introduction	9		Introduction	129
	Fetal Bovine Serum	10		Human Cytokines and	130
	Cell-specific FBS	10		Growth Factors	
	Fetal Bovine Serum Biotech	12		Other Species Cytokines	133
	Serum Services	13		and Growth Factors	
	FBS Good Product Family	14	6	Molecular Biology	134 - 147
	Bovine Serum	15		Introduction	135
	Other Animal Sera	15		Polymerases	136
	Serum Testing	16		Molecular Biology	142
	Certificates	17		Reagents	
	Human Serum	20	7	PANsys 3000	148 - 151
2	Serum-free Systems	24 - 59		Introduction	149
	Introduction	25		PANsys 3000	150
	Helping hand	27		Industrial Services	152 - 153
	Serum Replacements	28			
	Serum-free Media	32			
	Serum-free Stem Cell Media	46			
3	Media	60 - 107			
	Introduction	61			
	Cell Culture Media	62			
	Cell Specific Media	102			
4	Reagents	108 - 127			
	Introduction	109			
	Media Supplements	110			
	Buffered Salt Solution	111			
	Amino Acids and Vitamins	116			
	Antibiotics and Antifungal	117			
	Drugs				
	Enzymes for Cell	121			
	Dissociation				
	Attachment Factors	122			
	Separating Solutions	124			
	Separating Solutions	125			
	Pre-Filled				
	Cryo Preservation	126			
	Bovine Serum Albumin/	127			
	Human Serum Albumin				

Serum

Introduction	9
Fetal Bovine Serum	10
Cell-specific Fetal Bovine Serum	10
Fetal Bovine Serum Biotech	12
Serum Services	13
FBS Good Product Family	14
Bovine Serum	15
Other Animal Sera	15
Serum Testing	16
Certificates	17
Human Serum	20



Introduction

The function of serum in cell culture

- Stimulates cell growth, proliferation and differentiation through hormonal factors
- Adhesion factors facilitate and enhance cell attachment on culture dishes (bio-matrix)
- Transport and binding proteins provide hormones, minerals and lipids
- Inhibition of toxic substances by binding to serum proteins

Advantages of PAN-Biotech

- Own raw material resources in different countries: Brazil, United States of America (USA), Australia
- Certificate of Suitability (COS) no. R1-CEP 2002-167-Rev 00
- Licensed according to the EU-decree no. 1774/2002 with vet. no. DE 09 275 0001 14
- We offer special types of serum: charcoal absorbed, delipidized, dialyzed, gamma irradiated, heat inactivated and gamma globulin reduced
- Highest production and safety standards for serum manufacturing
- Best references from industry and research
- Extensive analyses and tests are presented in Certificate of Analysis (CoA)

Animal sera

The dose of serum added to a cell culture as a nutrient source depends on factors such as cell type, primary culture or cell line, adherent or suspension culture, and usually is in the range of 5 % to 15 % of the total liquid volume and most times used at 10 %.

Serum is produced from animal blood and fetal bovine serum is the most widely used because it contains an especially high amount of growth factors due to its origin – the blood of fetuses is a by-product of slaughtered cattle.

We warrant the submission of a complete documentation, consisting of a certificate of origin and a veterinary certificate, shipping documents and a certificate of analysis. Furthermore, every single procedure during an individual production process is documented and then summarized in a production protocol.

Production site:

PAN-Biotech GmbH
Am Gewerbepark 13
94501 Aidenbach / GERMANY

Serum Services

PAN-Biotech offers a variety of services and test procedures for your serum. We deliver these services fast and cost efficient, using the latest up-to-date techniques.

Profit from our expertise! If you need further special testing or particular services please contact PAN-Biotech. In most cases we can find a solution.

You can find more information about our serum services on page 13.

Fetal Bovine Serum

Bovine serum is the blood fraction remaining after the natural coagulation of blood, followed by centrifugation to remove any remaining red blood cells. The production of bovine serum at PAN-Biotech is tightly controlled, from the collection of serum at the slaughterhouse and throughout the whole production cycle which is

performed without exception in our own production facilities in Aidenbach, Germany. All serum lots are virus and mycoplasma tested.

Fetal Bovine Serum from different countries of origins is sterile filtered and quality tested.

Standard Grade

Fetal Bovine Serum Standard, South America origin	100 ml	P30-3305
	500 ml	P30-3306
Fetal Bovine Serum Standard, US origin	100 ml	P30-1405
	500 ml	P30-1406
Fetal Bovine Serum Standard, Australian origin	100 ml	P30-1305
	500 ml	P30-1306

Premium Grade

Fetal Bovine Serum Premium, South America origin	100 ml	P30-3301
	500 ml	P30-3302
Fetal Bovine Serum Premium , US origin	100 ml	P30-1401
	500 ml	P30-1402
Fetal Bovine Serum Premium, Australian origin	100 ml	P30-1301
	500 ml	P30-1302

Supreme Grade

NEW !

Fetal Bovine Serum Supreme, South America origin	100 ml	P30-3030
	500 ml	P30-3031

NEW !

Cell-specific Fetal Bovine Serum

Sera Low

Sera Low is a specially selected fetal bovine serum with low endotoxin level. The endotoxin level is lower than 1 EU/ml.

Advantages

- Low endotoxin level < 1EU/ml
- Better growth of cells
- Suitable for a great variety of cells

Sera Low, Fetal bovine serum, low Endotoxin	100 ml	P30-5100
	500 ml	P30-5500

Pansera ES

Our specially developed, proprietary processing methodology for serum enables us to offer a special fetal bovine serum for embryonic stem cells (ES).

Advantages

- Reproducible constant growth properties
- Improved cloning efficiency
- More undifferentiated clones
- Permanent strict quality control
- No need for further testing of different batches

Pansera ES , Fetal bovine serum, special designed for embryonic stem cells	100 ml	P30-2601
	500 ml	P30-2602
Pansera ES , Fetal bovine serum, US origin, special designed for embryonic stem cells	100 ml	P30-2608
	500 ml	P30-2609
Pansera ES , Fetal bovine serum, Australia origin, special designed for embryonic stem cells	100 ml	P30-2605
	500 ml	P30-2606

FBS MSC

NEW !

PAN-Biotech's „FBS MSC“ is especially tested for superior growth properties on human mesenchymal stem cells (hMSC). Cells are cultured in a medium containing 10% FBS of the tested batch. By flow cytometric analysis the cultured hMSCs are then assayed and analyzed for morphology, expansion and vitality of cells. Results are compared to those of a control serum which has shown good growth on hMSCs - and only the best batches are selected for „FBS MSC“.

Advantages

- Tested for mesenchymal stem cell compability
- Tested according EMEA 1793 and Ph.Eur.2262
- Virus and mycoplasma tested
- South America origin
- sterile filtered 0,2 µm

FBS MSC , Fetal bovine serum, South America origin, Mesenchymal stem cell tested	100 ml	P30-2611
	500 ml	P30-2612

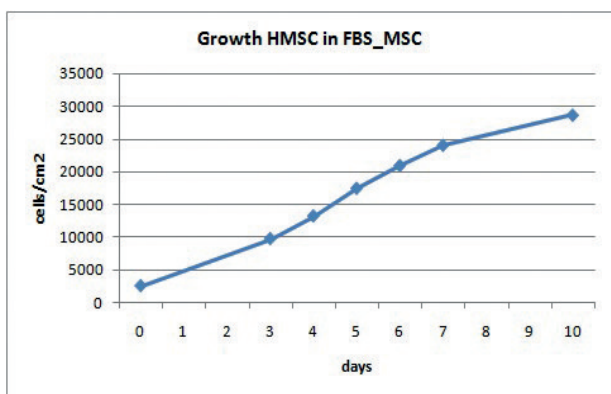

Fig.1: Growth of human adipose derived mesenchymal stem cells
 Growth conditions:
 Seeding density: 2500 cells/cm²
 Growth medium: DMEM with 4.5g/L Glucose, L-Glutamine and 10% FBS MSC



Fetal Bovine Serum Biotech

The bio-pharmaceutical industry is facing a constantly growing demand for high quality, extensively tested fetal bovine serum originating from FDA-approved regions. PAN-Biotech is meeting this demand and offers a new product, Fetal Bovine Serum Biotech, which is tested according to EMA (also known as EMEA) and Ph. Eur. guidelines.

Fetal Bovine Serum Biotech originates exclusively from Australia or the USA, both of them are approved regions by FDA's CFR. The entire production process is followed by close inspections and quality controls – from the collection of raw material to the final production and sterile filtration procedure, all steps are documented and traceable.

Especially a possible contamination with bovine viruses has to be excluded. Therefore, a multitude of tests is performed to meet highest safety requirements.

This product is tested according to EMEA CPMP/BWP/1793/02 and Ph. Eur. 01/2008:2262 upon request. In addition, EMA/410/01 rev. 3 and EMA/CHMP/

BWP/457920/2012 rev. 1 are also included as guidelines for testing procedures. Besides extensive testing for viral contamination, supplementary sterility testing is performed before, during and after filling of the product.

Application

Fetal Bovine Serum Biotech is particularly suited for the production of virus, vaccine, monoclonal antibodies, recombinant protein and growth factors, as well as the manufacture of other bio-pharmaceutical products.

Advantages

- Safety 100%
- Highest quality
- Tested according EMEA 1793 and Ph.Eur.2262
- Virus and mycoplasma tested
- sterile filtered 0,2 µm

Fetal Bovine Serum Biotech, US origin *	100 ml	P40-1401
	500 ml	P40-1402
Fetal Bovine Serum Biotech, Australia origin *	100 ml	P40-1301
	500 ml	P40-1302

* tested upon request and produced after receipt of order

Virus testing according EMEA guidelines

The following virus tests are performed according to EMEA guideline CPMP/BWP/1793/02:

- Bluetongue and related orbivirus
- Bovine adenovirus
- Bovine parvovirus
- Bovine respiratory syncytial virus (BRSV)
- Bovine viral diarrhoea virus (BVDV)
- Rabies virus (rabies)
- Reo virus
- Bovine polyoma virus (BPvV)

Activated charcoal treated serum

Serum is heated in a water bath with dextran and activated charcoal. The activated charcoal, together with the substances bound to it, is then removed by centrifugation and filtration.

Application

- Work involving reduced hormone content (steroids)
- Work involving reduced growth factors (prevention of cell differentiation)
- Receptor studies (e. g. estrogens)
- Minimizes lot-to-lot variations in serum

Delipidized serum

Lipids are removed from serum by affinity chromatography.

Application

- Lipid metabolism studies
- Arteriosclerosis research

Dialyzed serum

Serum is dialyzed with a 10,000 Dalton exclusion membrane against physiological saline solution (alternative DPBS) until the glucose content is below 10 mg/100 ml.

Application

- Radioactive labeling studies
- Hormone-free applications
- Tests intolerant for small molecules such as nucleotides (hypoxanthine, thymidine), amino acids (serine, alanine etc.), sugars or metabolites

Gamma irradiated serum

Serum is exposed to irradiation > 25 kGy

Application

- Biopharmaceutical production
- Virus production
- Vaccine production
- Manufacturing of diagnostic products

Heat inactivated serum

Serum is heated for 30 min to 56 °C in a water bath under repeated gentle mixing.

Application

- Measurements of lactate dehydrogenase in the culture supernatant as a marker for cell damage (serum LDH is inactivated by heat)
- Minimizes lot-to-lot variations in serum (all thermo-labile components are removed)
- Studies on vitamins and growth factors
- Enhance viral safety, since heat-labile viruses are inactivated
- Tests that do not tolerate presence of complement (complement destruction)

Tetracycline-free serum

Serum is tested for absence of tetracycline using the TET-off system (luciferase).

Application

- TET-on / TET-off regulated gene expression
- Transfections
- Expression studies

Ultra low IgG serum

The average IgG level in serum is in the range of 70 to 330 µg/ml. The IgG content in our Ultra low IgG serum is reduced by affinity chromatography (protein-G affinity column) to max. 5 µg/ml. The biological activity of serum is not affected.

Application

- Antibody production
- Monoclonal antibodies
- Radioactive labeling

FBS Good Product Family

The FBS Good product family contains specially processed serum products. Serum of selected batches is filtrated and separated into individual components by a sophisticated chromatographic method. The growth promoting components contained in the serum are then combined and restored in a defined process. Compared to conventional fetal bovine serum the FBS Good product family has been shown to support and promote cell growth of many different cell types equally well or even better.

Advantages

- Innovative new products
- Minor batch to batch variation
- Once tested – always similar quality
- No batch testing required
- No lot reservation required

FBS Good

By developing FBS Good we wanted to create a naturally defined serum with a sustained growth promoting property and a higher safety. FBS Good only contains serum of highest quality from defined countries as specified. It is not blended or enhanced by addition of growth factors or proteins.

FBS Good advantages

- Reproducible growth properties
- Suitable for a great variety of cells
- Continuous quality control

FBS Good , Filtrated bovine serum, EU approved	100 ml	P40-37100
	500 ml	P40-37500
FBS Good , Filtrated bovine serum, US origin	100 ml	P40-38100
	500 ml	P40-38500
FBS Good , Filtrated bovine serum, Australia origin	100 ml	P40-39100
	500 ml	P40-39500

FBS Good Forte

By developing FBS Good Forte we wanted to create a naturally defined serum with an increased growth promoting property and a higher safety. Therefore, additional growth fortifying compounds have been added to increase cell proliferation. FBS Good Forte only contains serum of highest quality from defined countries as specified. In addition, growth promoting and stabilizing compounds (e.g. proteins, salts, sugars, vitamins) have been added to further enhance the stability of the serum as well as the proliferation of many different cell types.

FBS Good Forte advantages

- Reproducible enhanced growth properties
- Suitable for many different cell types
- Continued high quality
- No more batch testing required

FBS Good Forte , Filtrated bovine serum with Additive Fortifier, EU approved	100 ml	P40-47100
	500 ml	P40-47500
FBS Good Forte , Filtrated bovine serum with Additive Fortifier, US origin	100 ml	P40-48100
	500 ml	P40-48500
FBS Good Forte , Filtrated bovine serum with Additive Fortifier, Australia origin	100 ml	P40-49100
	500 ml	P40-49500

Bovine Serum

Bovine Serum from different countries of origins is sterile filtered and quality tested.

Bovine Serum , variable origins	100 ml	P30-0601
	500 ml	P30-0602
Calf Serum - newborn , variable origins	100 ml	P30-0401
	500 ml	P30-0402

Other Animal Sera

Horse serum , sterile filtered	100 ml	P30-0701
	500 ml	P30-0702
Pig serum , sterile filtered	100 ml	P30-0901
	500 ml	P30-0902
Goat serum , sterile filtered	100 ml	P30-1001
	500 ml	P30-1002
Sheep serum , sterile filtered	100 ml	P30-4101
	500 ml	P30-4102
Lamb serum , sterile filtered	100 ml	P30-0801
	500 ml	P30-0802
Donkey serum , sterile filtered	100 ml	P30-0101
	500 ml	P30-0102
Rabbit serum , sterile filtered	100 ml	P30-1101
	500 ml	P30-1102
Mouse serum , sterile filtered	10 ml	P30-0200
	100 ml	P30-0201
Rat serum , sterile filtered	10 ml	P30-01901
	500 ml	P30-01901E
Chicken serum , sterile filtered	100 ml	P30-0301
	500 ml	P30-0302



All serum tested for virus and mycoplasma. Other serum upon request.

Test	Method
Albumin, Globulins	Serum protein electrophoresis
Bacterial count	Detection of total number of viable aerobic germs will be either done by membrane filtration or plate-flush-method or as surface method. The microorganisms are detected as colony forming units per ml (CFU/ml) on Caso agar plates.
Cell growth	Growth test of murine myeloma cells (SP2/0-Ag14) and murine fibroblasts (L929)
Cholesterol	Colorimetric test (CHOD-PAP)
Cloning efficiency	Murine myeloma cells (SP2/0-Ag14) are plated on microtiter plates (one cell per well). After 7 days of incubation the developed cell colonies are counted (= absolute cloning efficiency). The results are normalized to a previously tested reference serum (= relative cloning efficiency).
Endotoxin	Kinetic limulus amoebocyte lysate test (LAL)
Glucose	Colorimetric test (Trinder reaction)
Hemoglobin	Determined spectrophotometrically at three different wave lengths
IgG	Radial immune diffusion
Mycoplasma	Three different detection systems are used: DNA-binding fluorescence dye (DAPI), microscopic analysis of microbial cultures and test kits which detect mycoplasma specific enzymes
Osmolality	Analyzed by freezing point depression
pH value	Measured with pH-electrode
Plating efficiency	Murine fibroblasts (L929) are plated into a Petri dish. After 14 days of incubation the fixed cell colonies are stained with Giemsa and counted (= absolute plating efficiency). The results are normalized to a previously tested reference serum (= relative plating efficiency).
Sterility	The absence of bacterial or fungal contamination is verified by dual incubation with Caso-Bouillon or Thioglycolat-Bouillon according to Ph. Eur. at 32 °C and 20 °C
Tetracycline	Tested by a TET-off system of a CHO-luc cell line. Absence of tetracycline induces expression of luciferase, which is quantified using the luciferase test system from Promega.
Total protein	Colorimetric test (Biuret reaction)
Triglycerides	Colorimetric test (Trinder reaction)
Virus testing	The following viruses and the presence of their antibodies are tested by cytopathic effect: Bovine viral diarrhoea virus (BVDV), bovine herpes virus (BHV 1) and parainfluenza virus (PI-3)

Declaration

The manufacturing process and quality control testing are performed in accordance with the submitted records and with a suitable quality assurance system in compliance with ISO 9001 quality standards. This quality assurance system verifies traceability and batch consistency. PAN-Biotech conducts internal and external audits for its quality system on an annual basis.

In addition, PAN-Biotech audits its raw material serum suppliers on a cyclical basis and reviews the facilities, manufacturing processes and documentation for the collection, handling, storage and transport of raw serum. PAN-Biotech is willing to be inspected, in accordance with the relevant legislation, on request of a relevant authority before and/or after being granted a certificate of suitability.

 European Directorate for the Quality of Medicines & HealthCare Certification of Substances Division	 COUNCIL OF EUROPE CONSEIL DE L'EUROPE
Certificate of suitability No. R1-CEP 2002-167-Rev 00	
1	<i>Name of the substance:</i>
2	FOETAL BOVINE SERUM
3	<i>Name of holder:</i>
4	PAN BIOTECH GMBH
5	Am Gewerbepark 13
6	Germany-94501 Aidenbach
7	<i>Site(s) of production:</i>
8	PAN BIOTECH GMBH
9	Am Gewerbepark 13
10	Germany-94501 Aidenbach
11	THIS CERTIFICATE SUPERSEDES THE PREVIOUS CERTIFICATE
12	R0-CEP 2002-167-REV 01
13	After examination of the information provided on the origin of raw material(s) and type of
14	tissue(s) used and on the manufacturing process for this substance on the site(s) of
15	production mentioned above, we certify that the substance FOETAL BOVINE SERUM
16	meets the criteria described in the current version of the monograph Products with risk
17	of transmitting agents of animal spongiform encephalopathies no. 1483 of the European
18	Pharmacopoeia, current edition including supplements.
19	– country(ies) of origin of source materials: Australia and Brazil
20	– nature of animal tissues used in manufacture: Foetal bovine blood
21	The submitted dossier must be updated after any significant change that may alter the
22	quality, safety or efficacy of the substance, or that may alter the risk of transmitting
23	animal spongiform encephalopathy agents.
24	Manufacture of the substance shall take place in accordance with a suitable quality
25	assurance system such as ISO 9001, and in accordance with the dossier submitted.
26	Failure to comply with these provisions will render this certificate void.
27	The certificate is valid provided there has been no deterioration in the TSE status of the
28	country(ies) of origin of the source material.
Address: 7, allée Kastner, CS 30026 - F - 67081 Strasbourg (France) Telephone: 33 (0) 3 88 41 30 30 - Fax: 33 (0) 3 88 41 27 71 - e-mail: cep@edqm.eu Internet : http://www.edqm.eu	

Certificate of Analysis

FBS Premium

Origin: South America

Product	Description	Catalogue-No.	Size
FBS Premium	Fetal bovine serum, South America, Premium	P30-3300 P30-3301 P30-3302	50 ml 100 ml 500 ml

Lot No.: P150710

Date of production: July 21, 2015

Storage, stability, shipping:

Storage: -20 °C
 Stability: 6 years from date of production
 Shipping: on dry ice

Parameter	Result	Units
Appearance	amber liquid	n.a.
pH value	7.39	n.a.
Osmolality	313	mOsm/kg
Hemoglobin	18.0	mg/100 ml
Endotoxin	0.279	EU/ml
Total protein	38.75	mg/ml
Albumin	34.76	mg/ml
alpha-Globulin	1.67	mg/ml
beta-Globulin	2.33	mg/ml
IgG	300	µg/ml
Glucose	37.0	mg/100 ml
Cholesterol	32.8	mg/100 ml
Triglycerides	62.7	mg/100 ml

		Specification	Result
Sterility	Incubation at 32 °C	sterile	sterile
	Incubation at 20 °C	sterile	sterile
	Mycoplasma	not detected	not detected
Virus testing			
	Bovine viral diarrhoea virus (BVDV)	negative	negative
	Bovine herpes virus (BHV-1)	negative	negative
	Para-influenza virus type 3 (PI-3)	negative	negative
Antibody testing			
	Bovine viral diarrhoea virus (BVDV)	serological titer	< 1:2
	Bovine herpes virus (BHV-1)	serological titer	< 1:2
	Para-influenza virus type 3 (PI-3)	serological titer	< 1:2

Performance (cell culture tested)

Cell growth (SP2/0-Ag14)	Seed	day 2	day 5	day 7	[cells per ml]
Lot no. P150710	1.00 x 10e3	5.28 x 10e3	9.30 x 10e5	1.26 x 10e6	
Control serum	1.00 x 10e3	4.19 x 10e3	9.00 x 10e5	1.18 x 10e6	
Cell growth (L929)	[cells per ml]				
Lot no. P150710	1.00 x 10e4	7.10 x 10e4	8.45 x 10e5	1.13 x 10e6	
Control serum	1.00 x 10e4	6.90 x 10e4	8.90 x 10e5	1.01 x 10e6	
No. of	colonies/clones	absolute %	relative %		
Plating efficiency (L929)					
Lot no. P150710	490	98	100		
Control serum	491	98	100		
Cloning efficiency (SP2/0-Ag14)					
Lot. no. P150710	60	63	107		
Control serum	56	58	100		

TABLE 1:

Test	Method
pH value	Measured with pH-electrode
Osmolality	Analyzed by freezing point depression
Hemoglobin	Determined spectrophotometrically at three different wave lengths
Endotoxin	Kinetic limulus amoebocyte lysate test (LAL)
Total protein	Colorimetric test (Biuret reaction)
Albumin, Globulins	Serum protein electrophoresis (SPEP)
IgG	Radial immune diffusion
Glucose	Colorimetric test (Trinder reaction)
Cholesterol	Colorimetric test (CHOD-PAP)
Triglycerides	Colorimetric test (Trinder reaction)
Sterility	The absence of bacterial or fungal contamination is verified by dual incubation with Caso-Bouillon or Thioglycolat-Bouillon according to Ph. Eur. at 32°C and 20 °C
Mycoplasma	Three different detection systems are used: DNA-binding fluorescence dye (DAPI), microscopic analysis of microbial cultures and test kits which detect mycoplasma specific enzymes
Virus testing	The following viruses and the presence of their antibodies are tested by cytopathic effect: Bovine viral diarrhoea virus (BVDV), bovine herpes virus (BHV 1) and parainfluenza virus (PI-3)
Cell growth	Growth test of murine myeloma cells (SP2/0-Ag14) and murine fibroblasts (L929)
Plating efficiency	Murine fibroblasts (L929) are plated into a Petri dish, stained with Giemsa and after 14 days of incubation the fixed cell colonies are counted (= absolute plating efficiency). The results are normalized to a previously tested reference serum (= relative plating efficiency).
Cloning efficiency	Murine myeloma cells (SP2/0-Ag14) are plated on microtiter plates (one cell per well). After 7 days of incubation the developed cell colonies are counted (= absolute cloning efficiency). The results are normalized to a previously tested reference serum (= relative cloning efficiency).

Suitability
FOR RESEARCH USE ONLY!
**These products are intended for research or manufacturing use only.
Not for use in animal or human clinical or diagnostic application.**

Raw material is collected in regularly inspected facilities and processed by PAN Biotech in compliance with current Ph. Eur. guidelines for Bovine Sera. Processing of raw material into finished serum product is performed by employees of PAN Biotech.

Since raw serum is not pre-aged before filtration, turbidity or flocculent debris in form of precipitate may develop upon thawing or storage of the product. This occurrence does not adversely affect the performance of the serum.

Results shown in this compilation have been obtained by carefully performing standard test methods (see table 1). Since results for any specific test may vary depending on methodology, technical equipment, or test substances used, it is suggested that results for particularly important parameters be repeated by the end user of this product.

PAN Biotech has been assigned a Certificate of Suitability (Ref. No. R1-CEP 2002-167-Rev 00; renewed Nov/11/2008) by the European Directorate for the Quality of Medicines (EDQM) for production of bovine serum.

* n.a. = not available

This document has been produced electronically and is valid without a signature

Human Serum

Introduction	21
Human Serum	22
Seraclot	22
Human Platelet Lysate	23



Human Serum

Since 1988, PAN-Biotech is known as a renowned producer of sera for cell culture. Our customers benefit from our years of experience and highly specialized products.

Human Sera is the future for human cell therapy

Human serum is a highly sensitive material and is subject to stringent safety EU regulations. The average age of our donors is 26 years (n = 4000 single donations).

The sample collection is taken from human, healthy donors in Europe, certified donations institutions. The collection and testing of human plasma is carried out in accordance with the current version of Good Manufacturing Practice Annex 14th.

Each donation is precisely tested regarding various biophysical parameters and viral infections. From the collection of the plasma up to the packaging of the final product each individual production step is controlled and documented. Therefore, we provide our customers characterized with sera of consistently high quality, an absolute maximum level of safety and transparency.

In each batch of human serum among others the osmolarity, pH, protein- and glucose concentration, and cell growth are measured and the sterility tested.

Human Sera produced by PAN-Biotech consist of human material.

Human serum may be more suitable for the cultivation of human cells than FBS, since both the serum and the cultured cells belong to the same species. Thus, the physiological and natural conditions *in vitro* are reproduced most similar to those *in vivo*.

Therefore, human serum is particularly suitable for cell culture of human cells, tissue engineering of human tissue, human cell therapies (Clinical Trials I and II), particularly sensitive cell lines and immune cells.

PAN-Biotech offers three different categories of human serum:

„Off the clot“, Seraclot and converted human serum. Within these three categories it is possible to choose between a mixed blood groups pool, human serum AB, and human serum AB male.

Customer information

Human serum is a natural product. After the sterile filtration it is bottled and frozen as a clear solution. After thawing a slight blur may occur. Thus does not mean any loss of quality and the serum can be added to the medium without concerns.

Human serum is usually used in a concentration between 5% and 20%.

Cells cultured with FBS should be adapted step by step to the new serum. Initially, the cells should be cultivated for 4-6 days with a 10% serum mixture, consisting of 5% FBS and 5% human serum. Afterwards the final conversion to human serum can take place.

Advantages

- The Raw Material has been collected, prepared, tested and released in accordance with EU Regulations and current version of the Good Manufacturing Practice Annex 14
- Raw Material derived from donors who are negative in the tests HIV 1/2, HIV Ag, anti-HCV, Hbs Ag, Syphilis, HBV DNA, HCV RNA, HIV-1 RNA and are under medical supervision since 6 months
- All manufacturing steps and test results are documented accurately
- Single-use blood donor bags
- Endotoxin level commonly not higher than 5 EU/ml

Human Serum

Human serum is produced from human plasma by addition of calcium chloride. This results in clotting of the plasma. After the coagulation process the cellular and solid constituents of the serum are removed by centrifugation, the human serum is washed and concentrated by ultra-filtration. During this process calcium chloride and anticoagulants are reduced.

Finally filtered through a combination of depth- and membrane- filters. PAN-Biotech offers also converted human serum from donors with the blood group AB. Their blood does not contain anti-A nor anti-B antibodies, that could damage cultured cells and is therefore particularly suitable for immunological studies and hematopoietic studies.

Human serum, sterile filtered	100 ml	P30-2401
	500 ml	P30-2402
Human serum, Type AB	100 ml	P30-2501
	500 ml	P30-2502
Human serum, Type AB, male, sterile filtered	100 ml	P30-2901
	500 ml	P30-2902

Off-the-clot serum

Off-the-clot serum is prepared from human whole blood collected without anti-coagulant, allowed to clot at room temperature and then centrifuged to remove the clot.

We provide single donor units as well as pooled off-the-clot serum. Off-the-clot serum is filtered through depth and membrane filters before filling.

Human serum off-the-clot, sterile filtered	100 ml	P30-2701
	500 ml	P30-2702
Human serum off-the-clot, Type AB, male, sterile filtered	100 ml	P40-2701
	500 ml	P40-2702

Seraclot

Seraclot is a human serum, which is equal to the „off-the-clot“ serum in cell culture and in many cases exceeds its quality. An increased content of human growth factors expands the possibilities in therapeutic cell culture.

Seraclot is excellently suited for tissue engineering cell differentiation, human MSC, ASC/TERT1. Seraclot is composed of human material.

Seraclot, Human serum, sterile filtered	100 ml	P40-3011
	500 ml	P40-3012
Seraclot, Human serum, Type AB, male, sterile filtered	100 ml	P40-3001
	500 ml	P40-3002

Human Platelet Lysate (hPL)

NEW !

Human Platelet Lysate (hPL) is a xeno-free alternative to FBS. Human Platelet Lysate is a well promising source of bioactive substances as growth factors not only for in vivo wound healing and tissue repair, but also for the expansion of human cells in culture.

Platelets are a natural source of growth factors. They contain growth factors (platelet-derived growth factors (PDGFs), basic fibroblast growth factor (bFGF), transforming growth factor (TGF-β) and insulin-like growth factor-1 (IGF-1). Growth factors contained in hPL, like hormones and cytokines lead to a strong proliferation of human cells in culture and also have influence on the cell function. HPL is able to promote Mesenchymal stem cells (MSC) expansion, to decrease the time required to reach confluence and to increase CFU-F size, as compared to the FBS medium. ¹

Human Platelet Lysate promotes the expansion of human adherent and non-adherent primary cells and cell lines, including primary mesenchymal stroma cells (MSCs). MSCs occupy a high proliferation and differentiation potential. MSC can be cultivated and differentiated in vitro in different cells and tissue.

All in all hPL is a powerful and safe substitute for development of tissue- and cell-engineered products using MSCs.

HPL form PAN-Biotech is derived from volunteer donors. The single sample collections are taken from human, healthy donors in certified donation institutions in Europe. The collection of blood follows the EU standards (Directive 2002/98/EC - quality and safety standards for the collection, testing, processing, storage and distribution of human blood and blood components).

According to the EU standards the donors were tested for the following infection parameters: HBsAg, HBV DNA, anti-HCV, HCV RNA, anti-HIV, HIV RNA and Lues serology. It is possible to exclude the window period in case of NAT and antibodies / antigen tests (e.g. HBsAg and HBV NAT) with the current state-of-the-art test according to EU guidelines.

Instructions for use

Detailed instructions for use can be found at www.pan-biotech.com.

References

- 1) Platelet Lysate Promote Mesenchymal Stem Cell Expansion: A Safety Substitute for Animal Serum in Cell-Based Therapy Applications
Christelle Doucet et al., JOURNAL OF CELLULAR PHYSIOLOGY (2005)

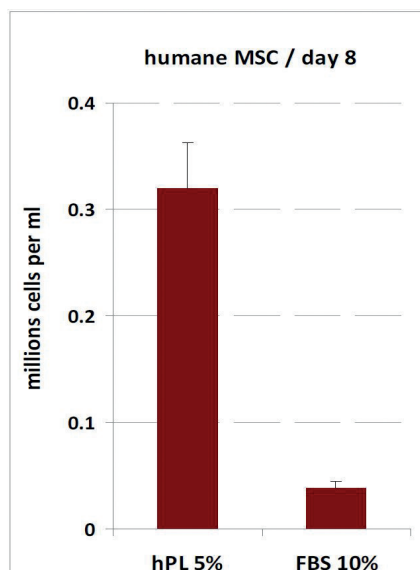

Fig.1: Humane MSC proliferation. Fibroblasts were expanded in presence of hPL or FBS. Picture is showing the average of three independent experiments. Growth-conditions: 2000 cells per ml / growth area 1.9 cm², medium (DMEM with 4.5 g/L glucose) contains 5% hPL or 10% FBS. During the growth phase the medium was not changed. After 8 days the cell density was determined.



Human Platelet Lysate NEW !	20 ml	P40-29020
	50 ml	P40-29050
	100 ml	P40-29100

Serum-free Systems

2

Introduction	25
Helping hand	27
Serum Replacements	
Panexin basic	28
Panexin NTA	29
Panexin NTS	30
Panexin BMM	31
Serum-free Media	
Panserin 401	32
Panserin 411	33
Panserin 411S	33
Panserin 412	34
Panserin 413, optimized	34
Panserin 416	34
Panserin H4000	35
Panserin H8000	36
Panserin C6000	37
Panserin 293A	38
Panserin 293S	38
Panserin T3	39
Panserin ProVero	39
Panserin 701	40
Panserin 802, optimized	40
Panserin PX10	41
Panserin PX40	42
Spodopan	43
Panserin S2	44
Endopan 300 SL	45
Serum-free Stem Cell Media	46



Introduction

Basics

Cell culture, the cultivation of cells isolated from live tissue *in vitro* (in the test tube), is an acknowledged and valuable tool in biomedical research for the acquisition of reproducible data. In addition, highly effective substances are produced in large-scale for medicine or biopharmaceutical and academic research by means of cell culture to an ever increasing degree (e.g. insulin, growth factors, monoclonal antibodies, or clotting factors).

Cell culture with serum

Cell cultures *in vitro* need nutrient solutions, so-called media, which provide an as close as possible simulation of the *in vivo* situation (in live organism). For this purpose these cell culture media – mixtures of nutrients, salts, trace elements, buffers, growth factors, protective binding and transport proteins and many additional components – have to be supplemented by a most natural, highly complex additive mixture. For many years, animal-derived and also human sera were the means of choice for production related reasons as well as for a lack of alternatives in more defined cell culture nutrients.

Function of serum in cell culture

- Growth factors and hormones stimulate cell growth, proliferation and differentiation
- Attachment factors favour or enable the attachment of cells to the culture dish (biomatrix)
- Transport and binding proteins support the supply of hormones, minerals and lipids
- Serum proteins bind toxic substances and stabilize sensitive growth factors

However, the use of serum in cell cultures, usually fetal bovine serum (FBS), is problematic for several reasons.

Disadvantages of serum in cell culture

- The composition of serum is variable and depends on the age of the fetus, on the origin and feeding of the animals, and on the time of year at slaughter
- Serum batches have to be tested extensively for their suitability before use
- Test results are often unsatisfactory and often not comparable because of the undefined and inconsistent nature of serum
- Risk of a contamination with bacteria, fungi, mycoplasma and virus from serum
- Risk of contamination with TSE agents (transmissible spongiform encephalopathy)
- Possibility of impurities in the end products due to residual serum proteins or pyrogens
- Time-consuming purification of the end products from culture media containing serum
- Uncertain availability and increasing cost of serum

Serum-free cell culture

Because of the numerous disadvantages of a serum-containing cell culture, for many years considerable research and development efforts have been undertaken to finally establish cell cultures under serum-free conditions.

Advantages of a serum-free cell culture

- Lower risk of contamination with bacteria, fungi, mycoplasma or virus
- Defined and reproducible formulations result in more convincing and comparable research data
- Time-consuming batch tests are dispensable
- Elimination of a source for possible infectious agents (prions)
- Ease of purification of end products
- Fulfilment of legal requirements for the manufacturing of medical products
- Reduction of impurities in end products by culture residues

Introduction

Definitions

a) Serum-free (SF)

Serum-free media do not require supplementation with serum. Suitable for any cell culture, in which serum is not required/desired.

b) Animal-derived component-free (ADCF)

Media containing no components of animal or human origin. The risk of contamination is minimized.

c) Xeno-free (XF)

Media do not contain ingredients from (non-human) animals but may contain components derived from human sources (Also see ADCF).

d) Protein-free media (PF)

Protein-free media do not contain high molecular weight proteins or protein fractions, but may contain peptide fractions (protein hydrolysates), and are thus not chemically defined. Protein-free media facilitate the down-stream processing of recombinant proteins and the isolation of cellular products (e.g., monoclonal antibodies), respectively.

e) Fully defined (FD)

Media containing no undefined ingredients such as serum, platelet lysate, tissue extracts or plant hydrolysates. Ingredients are defined in terms of origin and purity with single components having a purity $\geq 98\%$.

f) Chemically defined media (CD)

Chemically defined media do not contain proteins, hydrolysates or any other components of unknown composition. Highly purified hormones or growth factors added can be of either animal or plant origin, or are supplemented as recombinant products.

References:

Barnes and Sato, 1980a,b; Bjare, 1992; Grillberger et al., 2009; Gstraunthaler, 2003; Taub, 1990; Van der Valk et al., 2010; J.Solomon, L.Csnototos et al., 2015

PAN-Biotech serum-free media products

Serum replacement

Many users strive to keep their basal medium, because the cells are acquainted to these media over a long time or extensive efforts have been made to find a suitable basal medium. With this in mind, PAN-Biotech has developed easy to use serum substitutes which can fully replace FBS in the medium. Since different cell types (e.g. adherent or suspension cells) require different nutritional and attachment factors, we have developed two different serum substitutes for these kinds of cells. Panexin NTA is designed for adherent cells and Panexin NTS is designed for suspension cells.

These serum replacements can be used in many cases without an adaptation of the cells and no or little weaning. In this case, our Panexins give an instant advantage over conventional serum-containing cultures, eliminating many of the above described limitations of cell cultures with FBS.

Stem and progenitor cell media

Research and development in the field of stem cell biology has been tremendously advanced in the last decade. Today, some cell types are being used in clinical studies or applications and several more are close to being employed in cellular therapy. One important aspect for any application of stem and progenitor cells in patients is the isolation and expansion of these cells under defined conditions. For this purpose, the presence of FBS in such cell cultures is undesirable.

PAN-Biotech is offering a full range of serum-free media for stem and progenitor cells for the most important fields of research and development. Some of these stem cell media are free of animal-derived components, enabling the culture of cells in conditions close to clinical application.

Quality assurance

Each batch of serum-free media is produced only with pretested premium raw materials to ensure the highest quality standards. Water is the main and determining basal ingredient for any cell culture medium. The condition of our pyrogen-free water is of extra purity with a conductance value of $0.055 \mu\text{S}/\text{cm}$. It is regularly tested, since a minimal variation in water quality will have detrimental effects on the cells in a serum-free culture. Each batch of Panexin or Panserin will not be released unless the quality control process is finished and all the required specifications have been met.

Helping hand

2

Cells	Medium	Cat. No.	SFM	PF	XF	ADCF	FD
Broad range of different cells	Panserin 401	P04-710401	✓				✓
Broad range of different cells	Panserin 411	P04-710411	✓				✓
Broad range of different cells (adherent culture)	Panserin 412	P04-710412	✓				✓
Broad range of different cells (adherent culture)	Panserin PX40	P04-710PX40	✓				
Broad range of different cells (adherent culture)	Panexin basic	P04-96090	✓				✓
Broad range of different cells (adherent culture)	Panexin NTA	P04-95070	✓				✓
Broad range of different cells (suspension culture)	Panexin NTS	P04-95080	✓				✓
CHO (suspension culture)	Panserin C6000	P04-716000	✓	✓	✓	✓	
Dendritic cells	Panserin 416	P04-716416	✓				
HEK-293 (adherent culture)	Panserin 293A	P04-710608	✓				
HEK-293 (suspension culture)	Panserin 293S	P04-710009	✓		✓	✓	
Hum. Keratinocytes	Panserin 801	P04-710801K (Kit)	✓				
Hybridoma	Panserin PX10	P04-710PX10	✓				
Hybridoma (suspension culture)	Panserin H4000	P04-714000	✓	✓	✓	✓	
Insect cells (suspension culture)	Spodopan	P04-850500	✓	✓	✓	✓	
Lymphocytes	Panserin 701	P04-710701	✓				✓
Mouse bone marrow macrophages	Panexin BMM	P04-951SA2	✓				✓
Myeloid/lymphoid cells	Panserin 411S	P04-7411S1	✓				✓
NIH-3T3A cells (suspension culture)	Panserin T3	P04-710100	✓				✓
Schneider Drosophila S2 cells	Panserin S2	P04-710200	✓	✓	✓	✓	
T-cells	Panserin 413	P04-71413	✓				
Vero cells (adherent cells)	Panserin ProVero	P04-710613	✓				✓

Abbreviations that are used in the table:

SFM = Serum Free Media
PF = Protein Free

XF = Xeno-free
FD = Fully defined

ADCF = Animal derived components free

Serum Replacements

Panexin basic

Panexin basic is a fully defined serum replacement for the cultivation of adherent and non-adherent cells under serum-free culture conditions or to significantly reduce the amount of serum in cell culture. It supports the growth of many cell types in an optimum manner without any extra handling compared to serum.

Composition

Panexin basic contains purified proteins, lipids, salts, amino acids, trace elements, hormones and a 3-dimensional substrate release system in an optimized formulation. It contains no growth factors, undefined hydrolysates or peptones.

Suitability

Panexin basic is suitable for the cultivation of a variety of adherent and non-adherent cells under serum-free culture conditions or to reduce the necessary FBS amount in cell culture.

Special advantages

Panexin basic is designed to replace or to reduce serum in the cell culture in a very simple manner. In most cases there is no need to change the basal medium. As Panexin basic is fully defined and contains no peptones or hydrolysates, lot testing is not necessary anymore. It also allows high reproducibility and simplified downstream process. Panexin basic contains no growth factors and enables defined proliferation and differentiation of stem cells. Characterization studies of growth factors will obtain more reproducible and clearer results. Panexin basic is also useful to develop sensitive cell-based in vitro tests and coculture procedures. For cell lines which require specific growth factors these should be added in a concentration as previously used.

Instructions for use

Detailed instructions for use can be found at www.pan-biotech.com.

References

For cell line references please see our homepage (www.pan-biotech.com).

Effect of Panexin basic in different cell lines

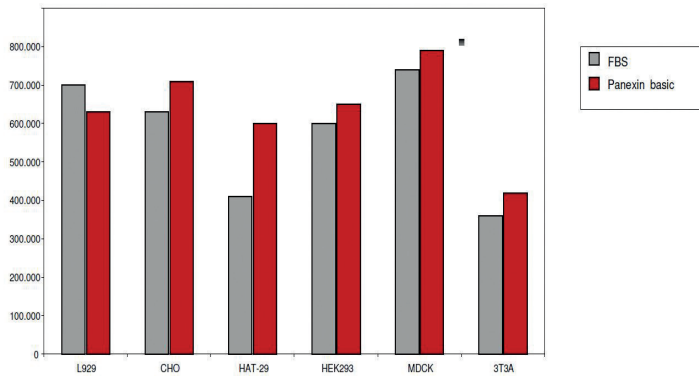

Fig. 1: Efficiency and Growth Stimulation of Panexin basic compared to FBS (each 10 % in DMEM/F12) for different cell types



Panexin basic ⁽¹⁾	100 ml	P04-96900
	500 ml	P04-96950

- (1) usually on stock
- (2) minimum order 20 pieces
- (3) available upon request

Serum Replacements

Panexin NTA

Panexin NTA is a defined serum replacement for the cultivation of adherent cells under serum-free conditions. Panexin NTA is developed with a unique technology and contains a special 3-dimensional substance release system (3D-SRS) for an optimal support of cells with nutrients and growth stimulants.

The ready to use, sterile solution is added to the culture medium in a final concentration of 10%. It supports the adherent growth of many cell types in an optimum manner.

Composition

Panexin NTA contains purified proteins, lipids, salts, amino acids, trace elements, attachment factors and hormones in an optimized formulation and a new 3-dimensional substance release system (3D-SRS). Panexin NTA contains no growth factors, undefined hydrolysates or peptones.

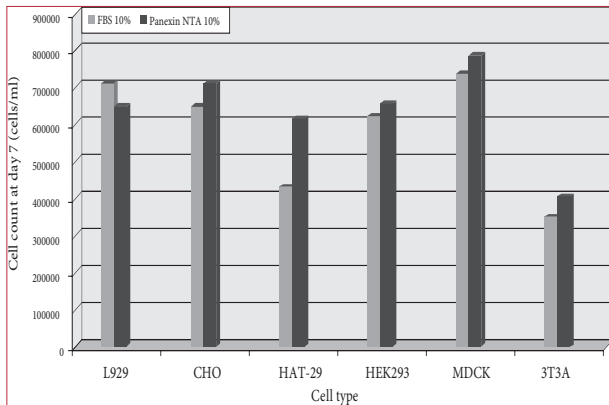

Fig.1: Efficiency and Growth Stimulation of Panexin NTA compared to FBS (each 10 % in DMEM/F12)

Suitability

Panexin NTA is suitable for the cultivation of a variety of adherent cells under serum-free culture conditions.

Special advantages

It has been shown for many cell lines that Panexin NTA can fully replace FBS. Due to selected and pretested raw materials Panexin NTA batches are very homogeneous. Therefore the complex batch testing known from FBS can be omitted with the use of Panexin NTA. In addition, there is no need to change the previously used basal medium.

Panexin NTA is completely defined and contains no undefined peptones or hydrolysates. Therefore, the interpretation of results from studies on effects of individually added growth factors is easier and more reliable in serum-free conditions. For cell lines which require specific growth factors these should be added in a concentration as previously used. As a basal medium you may use classical standard media such as RPMI 1640, DMEM (high or low glucose), DMEM/F12, IMDM and so on. Make sure that L-glutamine is present in sufficient quantity (possibly supplement glutamine).

Depending on the cell type, some differences in morphology or proliferation rate may be observed with various standard media. Many applications were performed with DMEM or DMEM/F12 for adherent cells. With these combinations very good growth stimulation was achieved in a range of 5% to 15% Panexin NTA.

For more demanding cells an adaptation to Panexin NTA may be necessary.

Instructions for use

Detailed instructions will be provided with the accompanying datasheet for Panexin NTA and can also be found at www.pan-biotech.com.

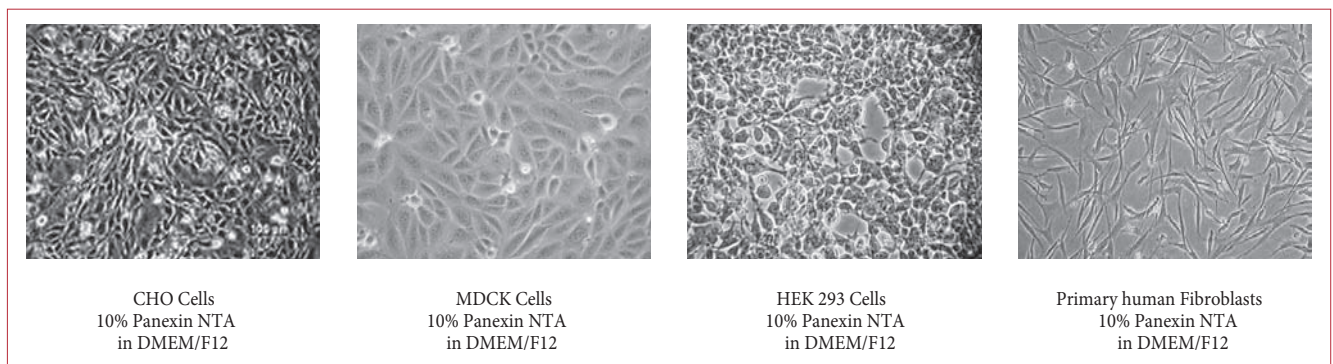

Fig.2: Different Cell Lines in DMEM/F12 with 10% Panexin NTA

References

- a) Hashimoto J et al. (2006) Regulation of Proliferation and Chondrogenic Differentiation of Human Mesenchymal Stem Cells by Laminin-5 (Laminin-332). *Stem Cells* 24:2346
- b) Traeger T et al. (2008) Detrimental Role of CC Chemokine Receptor 4 in Murine Polymicrobial Sepsis. *Infection and Immunity* 11:5285

Panexin NTA ⁽¹⁾	100 ml	P04-95700
	500 ml	P04-95750

- (1) usually on stock
- (2) minimum order 20 pieces
- (3) available upon request

Serum Replacements

Panexin NTS

Panexin NTS is a defined serum replacement for the cultivation of suspension cells under serum-free conditions. Panexin NTS is developed with a unique technology and contains a special 3-dimensional substance release system (3D-SRS) for an optimal support of cells with nutrients and growth stimulants. The ready-to-use, sterile solution is added to the cell culture medium in a final concentration of 10%. It supports the growth of many cell types in an optimum manner.

Composition

Panexin NTS contains purified proteins, lipids, salts, amino acids, trace elements, and hormones in an optimized formulation and a new 3-dimensional substance release system (3D-SRS). Panexin NTS contains no growth factors, undefined hydrolysates or peptones.

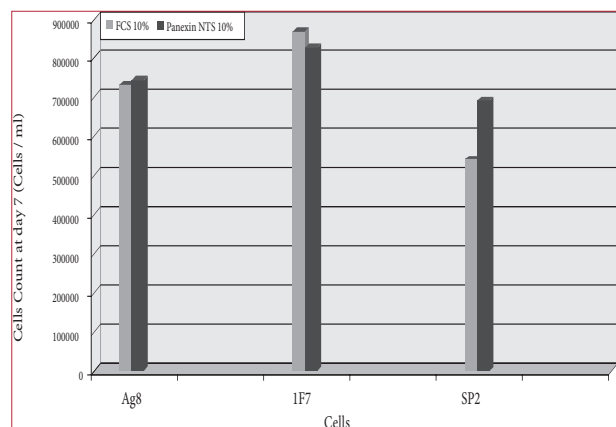

Fig.1: Efficiency and Growth Stimulation of Panexin NTS compared to FBS (each 10 % in RPMI)

Suitability

Panexin NTS is suitable for the cultivation of a variety of non-adherent suspension cells under serum-free conditions.

Special advantages

Panexin NTS can be used for many cell lines to replace FBS. Due to selected and pretested raw materials Panexin NTS batches are very homogeneous. Therefore the complex batch testing known from FBS can be omitted with the use of Panexin NTS. In addition, there is no need to change the previously used basal medium. Panexin NTS is completely chemically defined and contains no growth factors, undefined peptones or hydrolysates. Therefore, the interpretation of results from studies on effects of individually added growth factors is easier and more reliable in serum-free conditions. For cell lines which require specific growth factors, these should be added in a concentration as previously used.

For more demanding cells an adaptation to Panexin NTS may be necessary.

Instructions for use

Detailed instructions will be provided with the accompanying datasheet for Panexin NTS. In addition, instructions for use can also be found at www.pan-biotech.com.

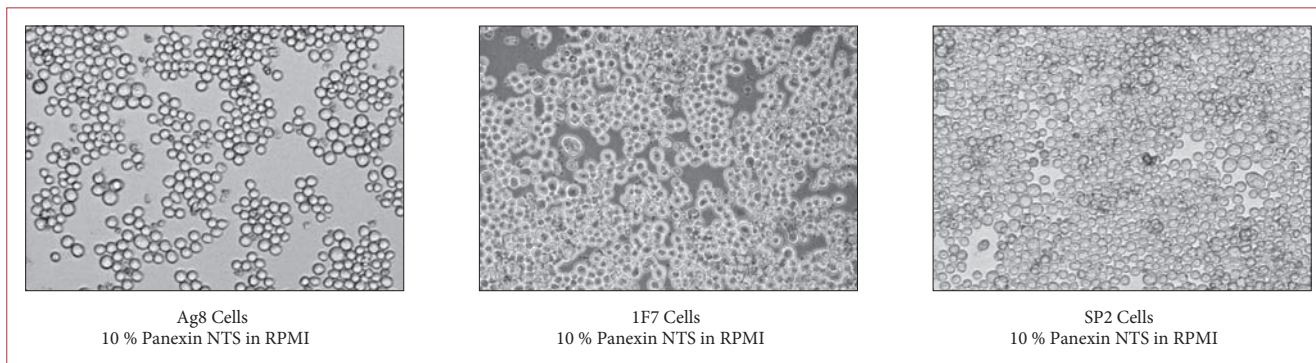

Fig.2: Different Cell Lines in RPMI with 10 % Panexin NTS

References

- a) Breitbart K et al. (2009) Caspase-1 Mediates Resistance in Murine Melioidosis. *Infection and Immunity* 4:1589
- b) Into T et al. (2008) Regulation of MyD88-Dependent Signaling Events by S Nitrosylation Retards Toll-Like Receptor Signal Transduction and Initiation of Acute-Phase Immune Responses. *Molecular and Cellular Biology* 4:1338

Panexin NTS ⁽¹⁾	100 ml	P04-95800
	500 ml	P04-95850

- (1) usually on stock
- (2) minimum order 20 pieces
- (3) available upon request

Serum Replacements

Panexin BMM

Panexin BMM is a defined serum replacement for the cultivation of macrophages from mouse bone marrow (murine bone marrow derived macrophages, BMM) under serum-free conditions. The ready-to-use sterile solution in a final concentration of 5 % is added to the basal medium RPMI 1640, supplemented with 50 µM Mercaptoethanol and 2 ng/ml GM-CSF mur. rec.

Composition

Panexin BMM contains purified proteins, lipids, salts, amino acids, trace elements, attachment factors and hormones in an optimized formulation. It contains no growth factors, undefined hydrolysates or lysates (e. g. Peptones).

Suitability

Panexin BMM has been developed for the generation of murine macrophages from bone marrow under serum-free conditions. This achieves standardized conditions and reproducible results.

Special advantages

Panexin BMM allows the generation of murine macrophages from bone marrow under standardized serum-free conditions. The results will be more comparable, as undefined components – like in serum-containing cultures – are eliminated. In Panexin BMM matured macrophages will show excellent attachment capabilities.

Instructions for use

Detailed instructions will be provided with the accompanying datasheet for Panexin BMM and can also be found at www.pan-biotech.com.

References

Kristin Eske, Katrin Breitbach, Jens Köhler, Patimaporn Wongprompitak and Ivo Steinmetz (2008). Generation of murine bone marrow derived macrophages in a standardised serum-free cell culture system, *Journal of Immunological Methods*.

Panexin BMM ⁽¹⁾	100 ml	P04-951SA2
----------------------------	--------	------------

(1) usually on stock

(2) minimum order 20 pieces

(3) available upon request

Serum-free Media

Panserin 401

Panserin 401 is a complete ready-to-use medium for the serum-free cultivation of a multitude of adherent and non adherent cells.

Composition

Based on Iscove`s MEM, trace elements, albumin, cholesterol, soy lipids and vitamins were added to the medium. It does not contain any growth or attachment factors.

Suitability

Panserin 401 is a multi-purpose medium suitable for a variety of cells. As the medium contains no growth factors there is a possibility to investigate the effects of specific growth factors added to the cell culture. Panserin 401 does not contain any attachment factors. With some cell types a pre-treatment of the cell culture vessels with gelatine, collagen, poly-D-lysine or fibronectin may support or enable a culture under serum-free conditions. Please note that a coating may be especially important with low seeding densities. With every adaption to serum-free media, changes of the cells should be taken into consideration. These changes may concern morphology, karyotype, surface markers and so on. Thus cells in serum-free medium may not be identical with those from cultures containing serum in which they originated (selection).

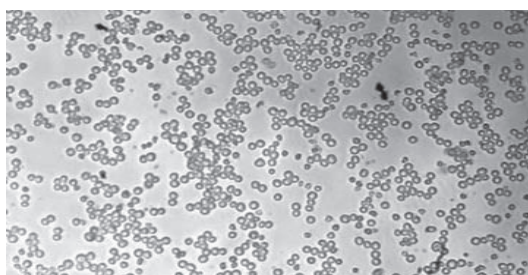

SP2/O-Ag-14 in Panserin 401 without prior adaption

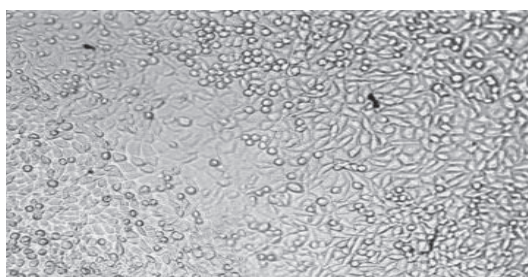

L 929 in Panserin 401 without prior adaption

Fig 1.: SP2/O-Ag-14 and L929 in Panserin 401

Panserin 401 ⁽¹⁾	100 ml	P04-710401M
	500 ml	P04-710401

Among others the following cells have been cultivated successfully:

- Hybridoma
- Lymphocytes
- Macrophages
- Fibroblasts
- Melanocytes
- Carcinoma cells
- HEK-cells
- HeLa-cells
- CHO-cells

Instructions for use

Detailed instructions will be provided with the accompanying datasheet for Panserin 401. In addition, instructions for use can also be found at www.pan-biotech.com.

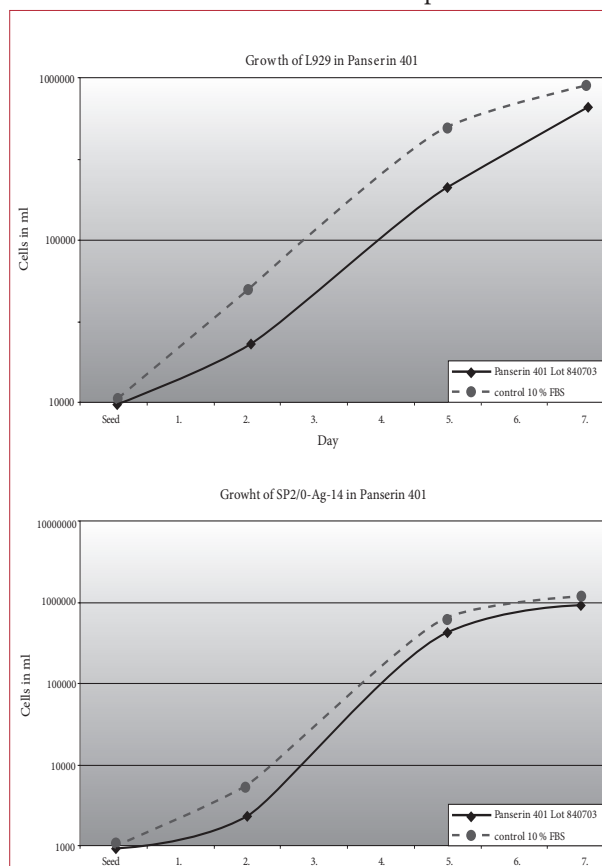

Fig 2.: Growth curves for L929 and SP2/O-Ag-14 in Panserin 401

References

- Pilar S et al. (2002) Contribution of CD3γ to TCR regulation and signaling in human mature T lymphocytes. *International Immunology* 11:1357
- Toptan T et al. (2010) Rhadinovirus vector-derived human telomerase reverse transcriptase expression in primary T cells. *Gene Therapy* 17:653
- Martin F et al. (2005) Lentiviral vectors transcriptionally targeted to hematopoietic cells by WASP gene proximal promotor sequences. *Gene Therapy* 12:715
- Montzka K et al. (2010) Expansion of human bone marrow derived mesenchymal stromal cells: serum-reduced medium is better than conventional medium. *Cytotherapy* 5:587

- (1) usually on stock
- (2) minimum order 20 pieces
- (3) available upon request

Serum-free Media

Panserin 411

Panserin 411 is a complete, ready-to-use medium for the serum-free cultivation of a multitude of adherent and non adherent cells which are Insulin-dependent (e.g. CHO-cells).

Composition

Based on Iscove's MEM, trace elements, albumin, cholesterol, soya lipids, vitamins and insulin were added to the medium. It does not contain any growth or attachment factors.

Suitability

Panserin 411 is a multi-purpose medium suitable for a variety of cells. In Panserin 411 adherent as well as non adherent cells can be cultivated. As the medium contains no growth factors there is a possibility to investigate the effects of specific growth factors added to the cell culture. Panserin 411 does not contain any attachment factors. With some cell types a pre-treatment of the cell culture vessels with gelatine, collagen, poly-D-lysine or fibronectin may support or enable a culture under serum-free conditions. Please note that a coating may be especially important with low seeding densities.

With every adaption to serum-free media, changes of the cells should be taken into consideration. These changes may concern morphology, karyotype, surface markers and so on. Thus cells in serum-free medium may not be identical with those from cultures containing serum in which they originated (selection).

Instructions for use

Detailed instructions will be provided with the accompanying datasheet for Panserin 411 and can also be found at www.pan-biotech.com.

Panserin 411S

Panserin 411S is a complete, ready-to-use medium for the serum-free cultivation of myeloid and lymphoid cells for cytological examination.

Composition

Based on RPMI 1640 medium, additional trace elements, albumin, cholesterol, soya lipids, vitamins and hormones are added.

Suitability

Panserin 411S is a serum-free complete medium for the cultivation of myeloid and lymphoid cells from peripheral blood or bone marrow. It is therefore suitable for a rapid expansion of blood cells in order to investigate leukemic diseases (ALL, AML, CLL, CML, MPN, MDS). The state of the art diagnostic techniques of leukemic diseases are based on the interaction of cytomorphology including cytochemistry with immunophenotyping, chromosome banding analysis, FISH and molecular genetics. In Panserin 411S the number and quality of metaphases are significantly higher and independent of individual batches as compared to serum-containing media.

Instructions for use

Detailed instructions will be provided with the accompanying datasheet for Panserin 411S and can also be found at www.pan-biotech.com.

Panserin 411 ⁽¹⁾	500 ml	P04-710411
Panserin 411S ⁽¹⁾	100 ml	P04-7411S0
	500 ml	P04-7411S1
	1 L	P04-71411S

(1) usually on stock

(2) minimum order 20 pieces

(3) available upon request

Serum-free Media

Panserin 412

Panserin 412 is a complete, ready-to-use medium for the serum-free cultivation of a multitude of adherent cells.

Composition

Based on Iscove's MEM, trace elements, albumin, cholesterol, soya lipids and vitamins and were added to the medium. It does not contain any growth factors.

Suitability

Panserin 412 is a multi-purpose medium suitable for a variety of adherent cells. Panserin 412 contains special attachment factors for the successful cultivation of cells that hardly attach. With every adaption to serum-free media, changes of the cells should be taken into consideration. These changes may concern the morphology, the karyotype, the surface marker etc. Thus cells in serum-free medium don't always have to be identical with those from the culture containing serum in which they originate (selection).

Instructions for use

Detailed instructions will be provided with the accompanying datasheet for Panserin 412 and can also be found at www.pan-biotech.com.

Panserin 413, modified

Panserin 413 modified is a ready-to-use medium optimized for the serum-free in vitro cultivation of lymphocytes and hybridoma cells.

Composition

Based on RPMI 1640/DMEM-F12, trace elements, albumin, cholesterol, soya-lipids and vitamins were added to the medium.

Suitability

Panserin 413 modified is a ready-to-use medium optimized for the serum-free in vitro cultivation of human immune cells isolated from peripheral whole blood. The Panserin 413 modified formulation allows the efficient expansion of T-cells, CIK, LAK and NK cells without the addition of bovine serum or (autologous) human serum. Recombinant cytokines, required for the optimal growth of immune cells have not been added to Panserin 413 modified yet. This allows the users the flexibility to prepare a medium that meets their requirements.

Instructions for use

Detailed instructions can be found at www.pan-biotech.com.

Panserin 416

Panserin 416 is a serum-free medium (basal medium) which is, after supplementation with growth factors, suitable for the production of dendritic cells.

Composition

Based on RPMI 1640/DMEM/F-12, trace elements, albumin, cholesterol, soya-lipids and vitamins were added to the medium. A growth factor mixture is also supplied which has to be added to the medium just before use.

Suitability

Dendritic cells are highly specialized antigen-presenting cells and can initiate and regulate antigen-specific immune responses. This ability can be used in order to generate immune responses against certain proteins of tumour cells and thus the immune system itself could be able to fight against tumours. Dendritic cells have been isolated from a great variety of non-lymphatic and lymphatic tissues of human beings, mice and other species.

For the generation of tumour vaccines, dendritic cells can be produced from the peripheral blood of tumor patients. In clinical studies the principal effectiveness of a vaccination with dendritic cells has been shown.

Instructions for use

Detailed instructions will be provided with the accompanying datasheet for Panserin 416 and can also be found at www.pan-biotech.com.

Panserin 412 ⁽¹⁾	500 ml	P04-710412
Panserin 413 ⁽³⁾	500 ml	P04-71413
Panserin 416 ⁽³⁾	500 ml	P04-710416

(1) usually on stock

(2) minimum order 20 pieces

(3) available upon request

Serum-free Media

Panserin H4000

Panserin H4000 is a protein-free ready-to-use medium for an optimized growth of myeloma and hybridoma-cell lines in suspension culture for the production of monoclonal antibodies. Panserin H4000 is suitable for spinner cultures, roller bottles and tissue culture bioreactors.

Composition

Panserin H4000 consists of a balanced mixture of salts, amino acids, vitamins, trace elements, hormones and is enriched with selected herbal hydrolysates for an optimized growth of myeloma and hybridoma cell lines. As Panserin H4000 is free of animal or human components it is predestined for the use in sensitive production areas (e.g. production of diagnostic or therapeutic tools) where safety requirements prohibit the use of human or animal components.

Suitability

Cultivation of myeloma and hybridoma cell lines for the production of monoclonal antibodies.

Special advantages

The formulation of the protein-free Panserin H4000 with a low concentration of plant hydrolysates enables a high cell yield in combination with excellent production rates of monoclonal antibodies. The ready to use protein-free medium allows easy handling and therefore reduces contamination risks and ensures for an easy and economic purification of the final products in downstream processes.

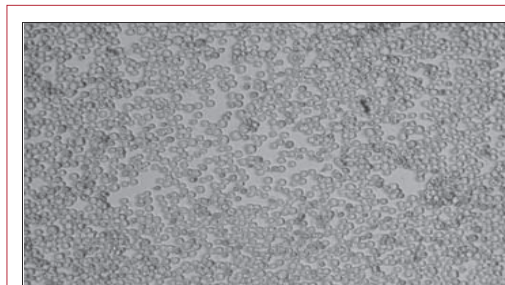

SP2/0-Ag-14 in Panserin H4000

Instructions for use

Detailed instructions will be provided with the accompanying datasheet for Panserin H4000. In addition, instructions for use can also be found at www.pan-biotech.com.

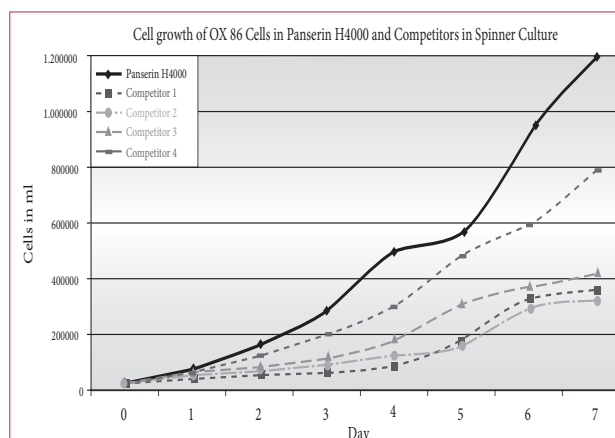

Panserin H4000 ⁽¹⁾	100 ml	P04-714000M
	500 ml	P04-714000

(1) usually on stock
 (2) minimum order 20 pieces
 (3) available upon request

Serum-free Media

Panserin H8000

Panserin H8000 is a protein-free, ready-to-use medium for an optimized growth of cholesterol-dependent myeloma and hybridoma cell lines in suspension culture for the production of monoclonal antibodies. Panserin H8000 is suitable for spinner cultures, roller bottles and bioreactors.

Composition

Panserin H8000 consists of a balanced mixture of salts, amino acids, vitamins, trace elements, hormones, bio-available cholesterol and is enriched with selected herbal hydrolysates for an optimized growth of cholesterol dependent myeloma and hybridoma cell lines.

Suitability

Cultivation of cholesterol-dependent myeloma and hybridoma cell lines for the production of monoclonal antibodies.

Special advantages

The formulation of the protein-free Panserin H8000 with a low concentration of plant hydrolysates enables a high cell yield in combination with excellent production rates of monoclonal antibodies. As Panserin H8000 is free of animal or human components it is predestined for the use in sensitive production areas (e.g. production of diagnostic or therapeutic tools) where safety requirements prohibit the use of human or animal components. The ready-to-use protein-free medium allows easy handling and therefore reduces contamination risks and ensures an easy and economic purification of final products in the downstream processing.

Instructions for use

Detailed instructions will be provided with the accompanying datasheet for Panserin H8000. In addition, instructions for use can also be found at www.pan-biotech.com.

Most hybridoma cell lines can be directly transferred from a serum-containing culture into a protein-free suspension culture. It should be noted here that the seeding density should be at least $1-3 \times 10^5$ cells.

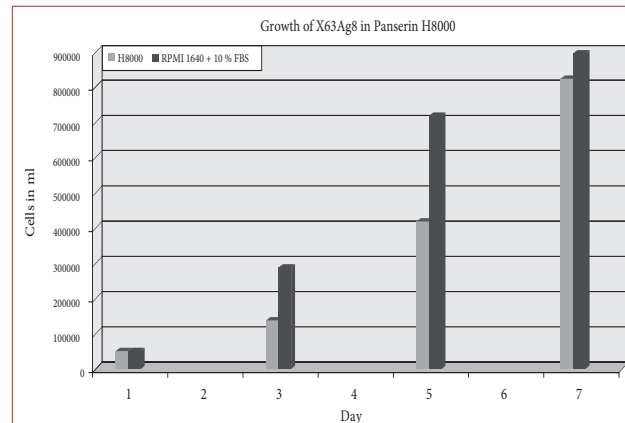

Panserin H8000 ⁽¹⁾	100 ml	P04-718000M
	500 ml	P04-718000

- (1) usually on stock
- (2) minimum order 20 pieces
- (3) available upon request

Serum-free Media

Panserin C6000

Panserin C6000 is a protein-free ready to use medium for an optimized growth of CHO-cells (Chinese Hamster Ovary) and their recombinant derivates in suspension culture. These cells are often used for the production of recombinant proteins for diagnostic or therapeutic purposes. Panserin C6000 is suitable for spinner cultures, roller bottles and tissue culture flasks and bioreactors.

Composition

Panserin C6000 consists of a balanced mixture of salts, amino acids, vitamins, trace elements, hormones and is enriched with select herbal hydrolysates for an optimized growth of CHO-cells in suspension culture. As Panserin C6000 is free of animal or human components it is predestined for the use in sensitive production areas (e.g. production of diagnostic or therapeutic tools) where safety requirements prohibit the use human or animal components.

Suitability

Protein-free cultivation of CHO-cells and their recombinant derivates in suspension culture for the production of recombinant proteins for diagnostics or therapeutic purposes.

Special advantages

The formulation of the protein-free Panserin C6000 with a low concentration of plant hydrolysates enables a high cell yield in combination with excellent production rates of recombinant proteins. The ready to use complete protein-free medium allows easy handling and therefore reduces contamination risks and ensures for an easy and economic purification of the final products in downstream processes. Due to the optimized composition of Panserin C6000 the cells expand and grow in single-cell suspension with a very low tendency to form aggregates.

Instructions for use

Detailed instructions will be provided with the accompanying datasheet for Panserin C6000. In addition, instructions for use can also be found at www.pan-biotech.com.

Most CHO-cells can be directly transferred from a serum containing adherent culture into the protein-free suspension culture. In most cases the stable suspension culture is developing within about 2 weeks.

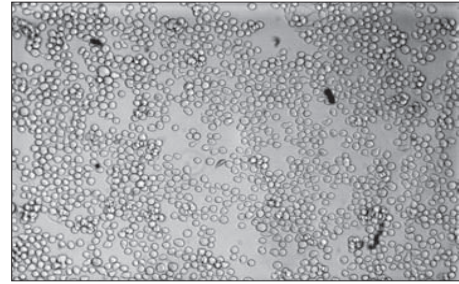

CHO cells in Panserin C6000

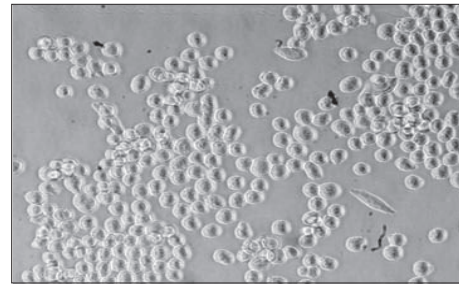

CHO cells in Panserin C6000

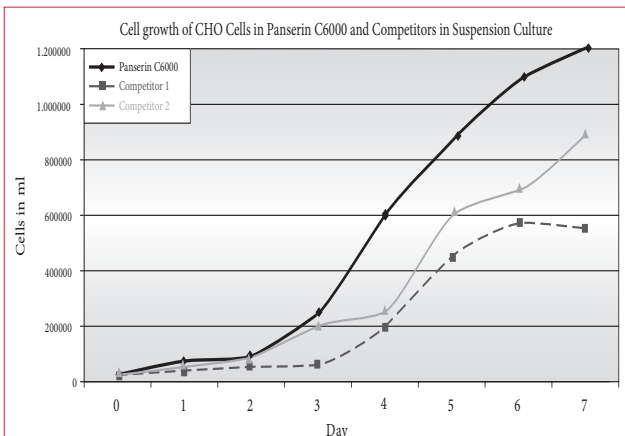

Panserin C6000 ⁽¹⁾	100 ml	P04-716000M
	500 ml	P04-716000

- (1) usually on stock
- (2) minimum order 20 pieces
- (3) available upon request

Serum-free Media

Panserin 293A

Panserin 293A is a complete ready to use medium for the serum-free cultivation of HEK293 cells (Human Embryonic Kidney) in adherent culture.

Composition

Based on DMEM additional trace elements, albumin, cholesterol, soy lipids, vitamins and hormones have been added to the medium.

Suitability

Panserin 293A is a particularly enriched medium optimized for the growth of HEK293 cells in adherent culture. HEK293 is frequently used for the expression of recombinant proteins and the proliferation of adenoviruses. Panserin 293A promotes a rapid attachment of the cells and guarantees high cell growth rates.

Instructions for use

Detailed instructions will be provided with the accompanying datasheet for Panserin 293A. In addition, instructions for use can also be found at www.pan-biotech.com.

Panserin 293A ⁽¹⁾	100 ml 500 ml	P04-710608M P04-710608
Panserin 293S ⁽¹⁾	100 ml 500 ml	P04-710609M P04-710609

Panserin 293S

Panserin 293S is a complete ready to use medium for the serum-free cultivation of HEK293 cells (Human Embryonic Kidney) in suspension culture.

Composition

Based on DMEM/F12 medium additional trace elements, cholesterol and herbal hydrolysates have been added. Panserin 293S does not contain any proteins or components of animal or human origin.

Suitability

Panserin 293S is a particularly enriched medium optimized for the growth of HEK293 cells in suspension culture and quickly provides high cell densities. Due to its protein-free formulation the purification of final products (recombinant proteins, viruses) from the cell culture is more convenient and economic. Cell clustering - often seen in serum-free suspension cultures - will be reduced significantly in Panserin 293S.

Instructions for use

Detailed instructions will be provided with the accompanying datasheet for Panserin 293S. In addition, instructions for use can also be found at www.pan-biotech.com.

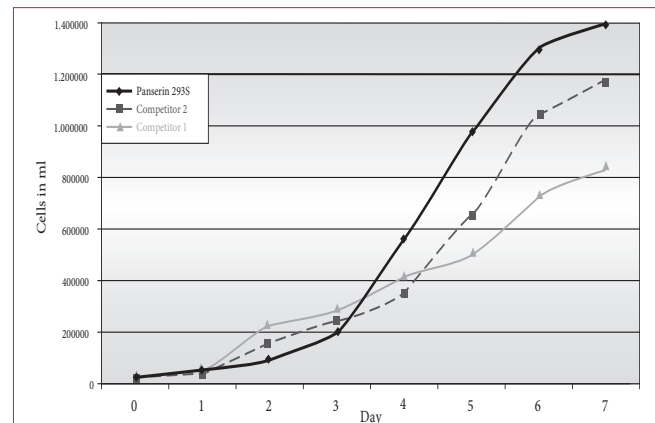

Fig.: Growth of HEK293 in Panserin 293S

- (1) usually on stock
- (2) minimum order 20 pieces
- (3) available upon request

Serum-free Media

Panserin T3

Panserin T3 is a ready-to-use serum-free complete medium for the cultivation of 3T3 cells in suspension culture.

Composition

Panserin T3 is a defined serum-free complete medium. Based on Iscove's MEM, this medium was supplemented with cholesterol, soy lipids, albumin, vitamins and trace elements. It contains no growth and attachment factors.

Suitability

Panserin T3 was developed for the serum-free cultivation of mouse fibroblasts (3T3A) in suspension.

Instructions for use

Detailed instructions will be provided with the accompanying datasheet for Panserin T3. In addition, instructions for use can also be found at www.pan-biotech.com.

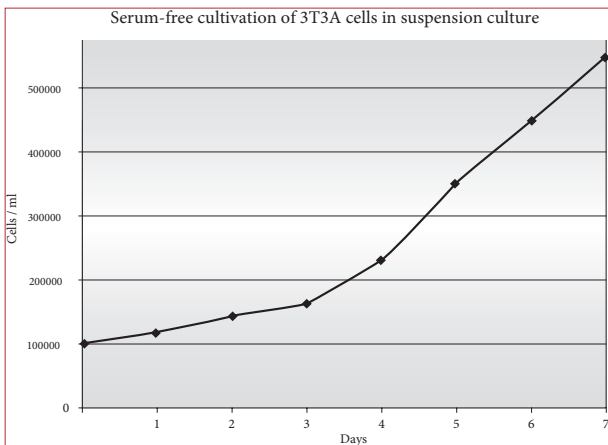

Fig.1: Growth of 3T3A-cells in Panserin T3

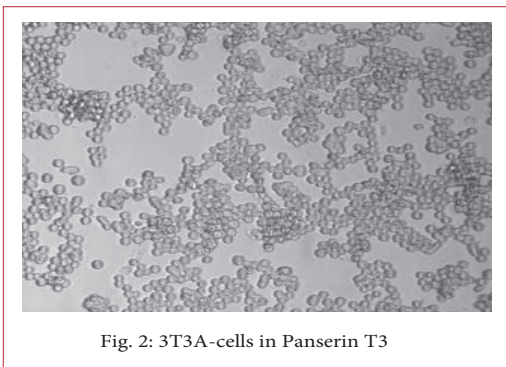

Fig. 2: 3T3A-cells in Panserin T3

Panserin ProVero

Panserin ProVero is a complete serum-free medium ready to use for the cultivation of Vero cells (kidney epithelial cells from African green monkey) in an adherent culture.

Composition

Panserin ProVero is based on DMEM/F12. It contains trace elements, albumin, cholesterol, soy lipids, vitamins, hormones and attachment factors.

Suitability

Cultivation of Vero cells in adherent culture (e.g. roller bottles)

Special advantages

Highly enriched medium for the fast growth and culture of adherent Vero cells.

Instructions for use

Detailed instructions will be provided with the accompanying datasheet for Panserin ProVero. In addition, instructions for use can also be found at www.pan-biotech.com.

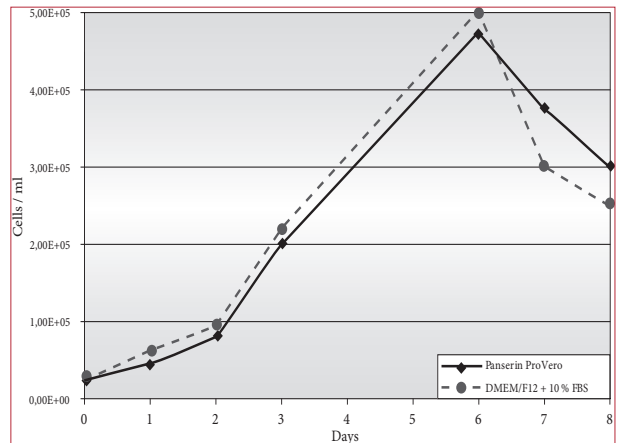

Fig.1: Growth of Vero-cells in Panserin ProVero

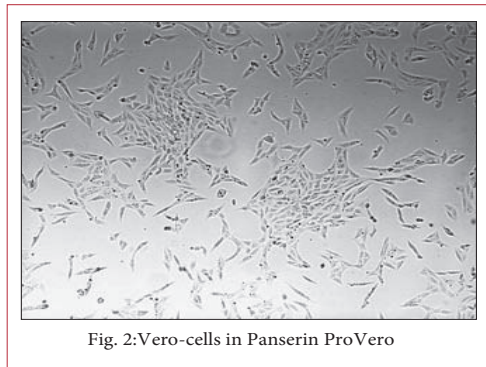

Fig. 2: Vero-cells in Panserin ProVero

Panserin T3 ⁽³⁾	500 ml	P04-710100
Panserin ProVero ⁽³⁾	500 ml	P04-710613

- (1) usually on stock
- (2) minimum order 20 pieces
- (3) available upon request

Serum-free Media

Panserin 701

Panserin 701 is a complete ready-to-use serum-free medium for the cultivation of lymphocytes from whole blood.

Composition

Based on Iscove's MEM the medium is enriched with additional trace elements, albumin, cholesterol, lipids and vitamins. It contains the mitogen phytohemagglutinin (PHA) for a growth stimulation of lymphocytes.

Suitability

Panserin 701 has been developed for the serum-free cultivation of lymphocytes from whole blood. The plant lectin (PHA) in Panserin 701 stimulates cell division.

Instructions for use

Detailed instructions will be provided with the accompanying datasheet for Panserin 701. In addition, instructions for use can also be found at www.pan-biotech.com.

Panserin 701 ⁽¹⁾	100 ml 500 ml	P04-710701M P04-710701
Panserin 802 ⁽³⁾	500 ml Kit	P04-710802K

Panserin 802, optimized**NEW !**

Panserin 802 is an optimized medium for the serum-free cultivation of human keratinocytes.

Composition

MCDB-153 is used as basal medium which has to be supplemented with the supplements provided just before use.

These supplements are:

- Bovine Pituitary Extract (BPE)
- Epidermal Growth Factor (EGF)
- Insulin
- Hydrocortisone
- Epinephrine
- Transferrin human holo

Suitability

Panserin 802 has been developed for the serum-free cultivation of human keratinocytes. Panserin 802 selectively supports the growth of human keratinocytes and concurrently prevents the overgrowth with fibroblasts.

Instructions for use

Detailed instructions will be provided with the accompanying datasheet for Panserin 802. In addition, instructions for use can also be found at www.pan-biotech.com.

- (1) usually on stock
(2) minimum order 20 pieces
(3) available upon request

Serum-free Media

Panserin PX10

Panserin PX10 is a ready-to-use serum-free complete medium for the cultivation of myeloma- and hybridoma cells for the production of monoclonal antibodies.

Composition

Based on RPMI 1640/DMEM/F-12, trace elements, albumin, cholesterol, soy lipids, vitamins and hormones were added to the medium. The medium does not contain any growth factors.

Suitability

Cultivation of myeloma- and hybridoma cells for the production of monoclonal antibodies.

Special advantages

Panserin PX10 is a ready-to-use, serum-free medium for the production of monoclonal antibodies. It contains no undefined peptones or hydrolysates. Due to its optimized composition Panserin PX10 shows significant growth stimulation even at low seeding densities. In addition to an excellent cell growth Panserin PX10 shows very good cloning properties. Conventional serum-free systems often require long and laborious adaptation steps and seeding densities of up to 10^5 cells/ml. In contrast, most clones can be directly transferred into Panserin PX10 culture. With Panserin PX10 clones can be obtained easily.

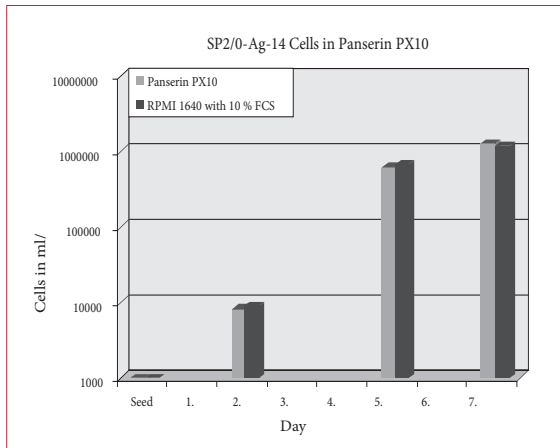

Typical growth curve of SP2/O-Ag-14 in Panserin PX10

Panserin PX10 ⁽¹⁾	500 ml	P04-710PX10
------------------------------	--------	-------------

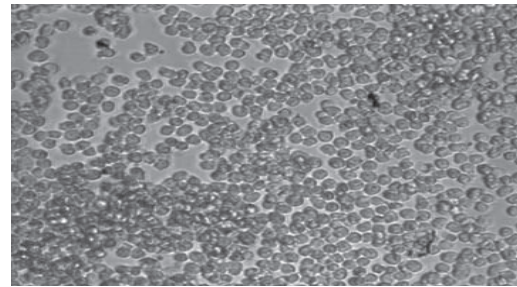

SP2/0-Ag-14 in Panserin PX10

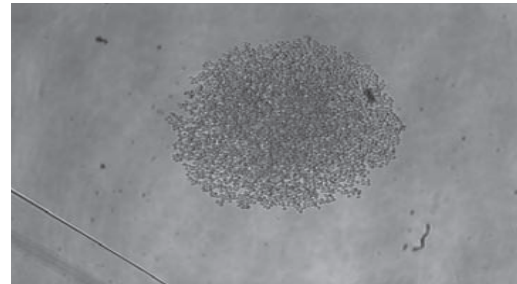

Cloning of SP2/0-Ag-14 in Panserin PX10

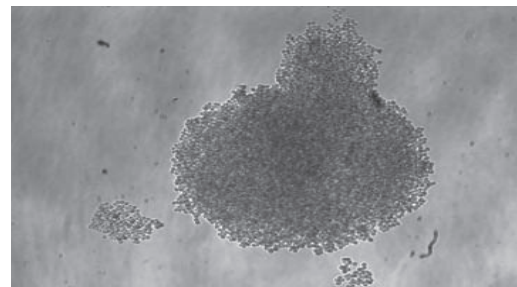

Cloning of SP2/0-Ag-14 in RPMI 1640 with 20% FCS

Sp2/0-Ag-14 cells were transferred from serum containing culture (RPMI 1640 with 10% FCS) directly into Panserin PX10. Seeding density 1.000 cells/ml. In comparison Sp2/0-Ag-14 in RPMI 1640 with 10% FCS.

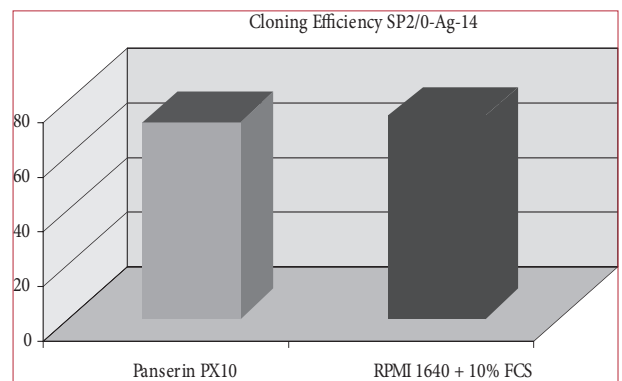

Instructions for use

Detailed instructions will be provided with the accompanying datasheet for Panserin PX10. In addition, instructions for use can also be found at www.pan-biotech.com.

- (1) usually on stock
- (2) minimum order 20 pieces
- (3) available upon request

Serum-free Media

Panserin PX40

Panserin PX40 is a ready-to-use complete medium for the serum-free cultivation of a variety of cells.

Composition

Based on RPMI 1640/DMEM/F-12, trace elements, albumin, lipoproteins, vitamins, hormones and attachment factors were added to the medium. The medium does not contain any growth factors.

Suitability

Cultivation of a variety of adherent cells under serum-free conditions (e. g. HEK, L929, CHO, MDCK, MDBK, 3T3A).

Special advantages

Panserin PX40 is a ready-to-use serum-free medium for the cultivation of a variety of adherent cells. The addition of attachment factors allows the cultivation of even highly demanding cells after a short adaptation phase.

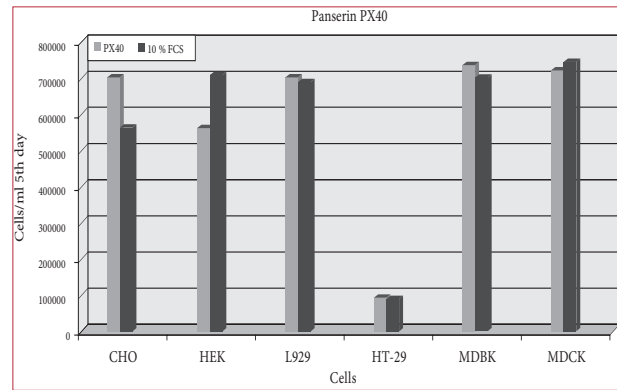

Instructions for use

Detailed instructions will be provided with the accompanying datasheet for Panserin PX40. In addition, instructions for use can also be found at www.pan-biotech.com.

Panserin PX40 ⁽¹⁾	500 ml	P04-710PX40
------------------------------	--------	-------------

- (1) usually on stock
- (2) minimum order 20 pieces
- (3) available upon request

Serum-free Media

Spodopan

Spodopan is a protein-free medium for an optimized growth of insect cells such as Sf9 and Sf21 (Spodoptera frugiperda) in suspension culture. Insect cells are often used for the industrial production of recombinant proteins.

Composition

Spodopan contains amino acids, vitamins, salts, trace elements, lipids and growth promoting factors in a formulation optimized for insect cells. It contains no protein or any other components of human or animal origin.

Suitability

Spodopan is suitable for the cultivation of insect cells and the production of recombinant proteins. (Baculovirus expression vector system, BEVS)

Special advantages

Spodopan with its protein-free formulation is free of human and animal components. This allows the production of recombinant proteins for medical and therapeutic purposes. The protein-free formulation also facilitates an easier and more economic purification of final products from the cell culture. Spodopan guarantees a high cell density with increased production of recombinant proteins (Baculovirus expression vector system).

Instructions for use

Detailed instructions will be provided with the accompanying datasheet for Spodopan. In addition, instructions for use can also be found at www.pan-biotech.com.

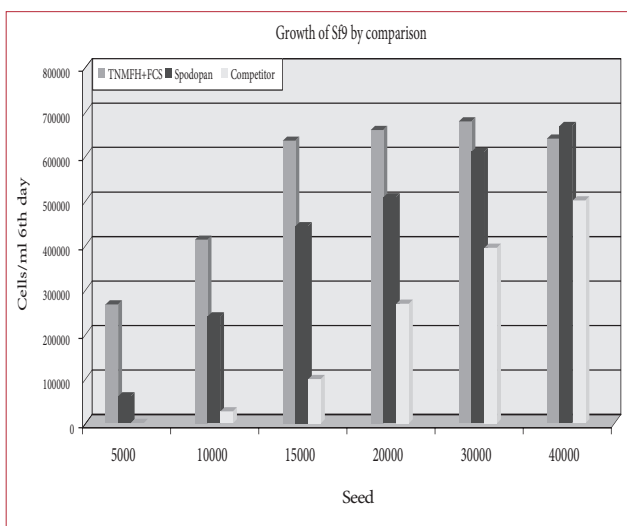

Sf9 cells in Spodopan

Spodopan ⁽¹⁾	100 ml	P04-850100
	500 ml	P04-850500

- (1) usually on stock
- (2) minimum order 20 pieces
- (3) available upon request

Serum-free Media

Panserin S2

Panserin S2 is a protein-free medium for an optimized growth of insect *Drosophila* S2 cells in suspension culture. Insect cells are widely used for the industrial production of recombinant proteins.

Composition

Panserin S2 contains amino acids, vitamins, salts, trace elements, lipids and growth promoting factors in a formulation optimized for the growth of insect cells. It contains no protein or any further components of human or animal origin.

Suitability

Panserin S2 is suitable for the cultivation of *Drosophila* S2 cells and the production of recombinant protein. (e.g. Baculovirus expression vector system, BEVS)

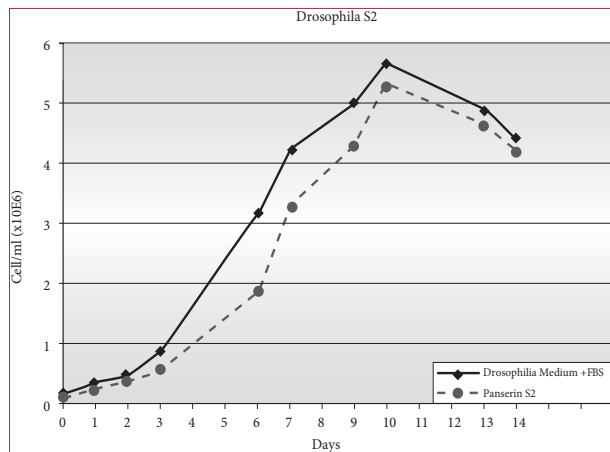

Special advantages

Panserin S2 with its protein-free formulation is free of human and animal components. This allows the production of recombinant proteins for medical and therapeutic purposes. The protein-free formulation also facilitates convenient and economic purification of final products from the cell culture. Panserin S2 guarantees a high cell density and viability resulting in an increased production and easy and economic purification of recombinant protein.

(Baculovirus expression vector system)

Instructions for use

Detailed instructions will be provided with the accompanying datasheet for Panserin S2. In addition, instructions for use can also be found at www.pan-biotech.com.

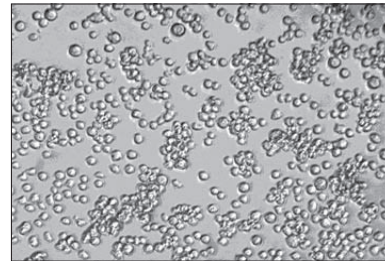

Fig. 1: *Drosophila* S2-cells in Panserin S2

Panserin S2 ⁽¹⁾	100 ml	P04-710210
	500 ml	P04-710200

- (1) usually on stock
- (2) minimum order 20 pieces
- (3) available upon request

Serum-free Media

Endopan 300 SL

Endopan 300 SL is the first complete medium specially developed for the serum-free in vitro culture of human endothelial cells containing all components necessary for optimal growth.

Endothelial cells line blood and lymphatic vessels and the internal cavities of the heart. They display a strongly flattened, polygonal form and mostly rest on a basal membrane. They adhere to each other by desmosomes and tight-junctions. With a total cell number of about one trillion (10^{12}), the endothelium is one of the biggest organs of the body and plays a key role in many physiological and patho-physiological processes (e.g. cell-based immune response, wound healing, inflammation, allergy, cardiovascular diseases, tumour growth). A huge number of soluble factors circulating in the blood or released by neighbouring cells control proliferation or apoptosis of endothelial cells and the invasion and migration of leucocytes to the endothelium, thereby regulating the maintenance, degeneration, or regeneration of blood vessels.

Composition and application

Endopan 300 SL ready-to-use is a complete medium specially developed for serum-free in vitro culture of human endothelial cells and it contains all components necessary for optimal growth. It is designed for use in an incubator at 37° C with a 5% CO₂ atmosphere. Endopan 300 SL kit is provided with a serum substitute (Panexin SL-S) and supplements in separate sterile packing.

Endopan 300 SL has been designed for serum-free culture of endothelial cells directly after isolation. This exclusive medium is optimized for the maintenance and expansion of endothelial cells under serum-free culture conditions. HUVEC cultured in Endopan 300 SL exhibit a typical endothelial morphology and express endothelial specific markers such as CD31 or von Willebrand Factor and bind UEA-1 lectin. Additionally, HUVEC in Endopan 300 SL have been shown to maintain endothelial cell signal transduction pathways. When using complete Endopan 300 SL the growth rate of HUVEC is similar to that obtained for cells cultured in endothelial growth media containing bovine serum and supplements.

Although not extensively tested, it has been shown that Endopan 300 SL can also be used with endothelial cells of bovine, pig, rat, mouse and rabbit origin.

Special advantages

Endothelial cell biology has been greatly advanced by studying cultured vascular endothelial cells in vitro. Traditionally, complete endothelial growth media contain animal serum. The advance of so-called low-serum media for endothelial cells has improved the quality of experimental data acquired in recent years. However, endothelial cells may synthesize substances which can not be detected due to their low quantity or masking effects from serum.

In the past, cellular signalling pathways in endothelial cells have not been decipherable experimentally because even low concentrations of serum present in traditional media induce an undefined and undesired stimulation of cell surface receptors or intracellular signalling which only may become evident under serum-free conditions. As endothelial cells move into the field of interest for vascular tissue engineering with potential therapeutic application, the presence of whole animal serum is undesirable for such applications.

Instructions for use

Detailed instructions will be provided with the accompanying datasheet for Endopan 300 SL. In addition, instructions for use can also be found at www.pan-biotech.com.

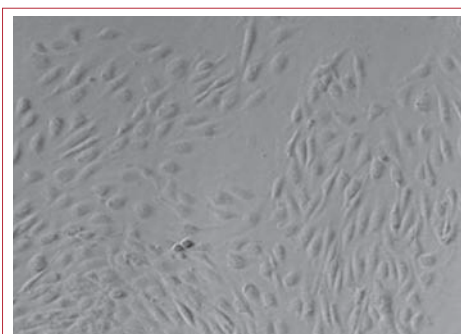

Sub-confluent HUVEC in ENDOPAN 300 SL

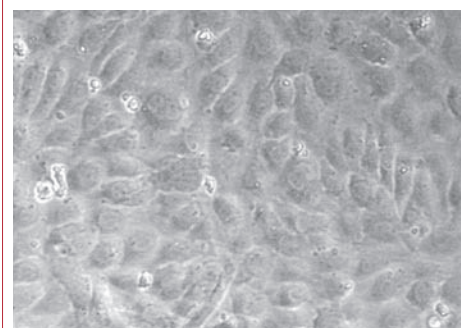

Confluent HUVEC in ENDOPAN 300 SL

Endopan 300 SL kit ⁽³⁾	500 ml	P04-0065K
-----------------------------------	--------	-----------

- (1) usually on stock
- (2) minimum order 20 pieces
- (3) available upon request

Serum-free Stem Cell Media

2

Introduction	47
Product Numbers	48
PowerStem ESPro1	49
PowerStem ESPro2	50
PowerStem EST	51
PowerStem HE1	52
PowerStem HE2	53
PowerStem iPS1	54
PowerStem iPS2	55
PowerStem MSC1	56
PowerStem HPSC	57
PowerStem PEC1	58

Introduction

Research and development in the field of stem cell biology has been tremendously advanced in the last decade. Today, some cell types are used in clinical studies or applications, and several more are close to being employed in cellular therapy. One important aspect for any application of stem and progenitor cells in patients is the isolation and expansion of these cells under defined conditions. For this purpose, the presence of FBS in cell cultures is undesirable. PAN-Biotech is offering a full range of serum-free media for stem and progenitor cells for the most important fields of research and development. Some of these stem cell media are free of animal-derived components, enabling the culture of cells in conditions close to clinical application.

In addition to hematopoietic stem and progenitor cells, also other types of stem and progenitor cells (e.g. mesenchymal stem cells, endothelial progenitor cells, and very small embryonic-like stem cells) circulate under steady-state conditions at detectable levels in peripheral blood, with their numbers increasing in response to stress, inflammation, tissue organ injury (e.g. myocardial infarction, stroke, or colitis), or mobilizing agents (e.g. colony-stimulating factors, G-CSF, GM-CSF).

Human mesenchymal stem cells (hMSC) have gained attention as one of very few cell types used clinically for cell therapy and tissue engineering due to their immuno-modulatory as well as their regenerative potential. MSC can be isolated from various sources: e.g. bone marrow, adipose tissue, or human umbilical cord. MSC have the capability to differentiate in vitro into connective tissue cells such as adipocytes, chondrocytes, and osteoblasts.

The umbilical cord has been the most popular source for easy to obtain stem cells. Hematopoietic stem cells harvested from cord blood have been successfully used for the treatment of diseases. Stem cell populations have also been reported in other compartments of the umbilical cord, amnion, sub-amnion, perivascular region, Wharton's jelly, umbilical blood vessel adventitia and endothelium.

New blood vessel formation occurs via angiogenesis or vasculogenesis, a process thought to be restricted to embryonic development. In 1997, postnatal vasculogenesis has been proposed as an important mechanism for angiogenesis via blood or bone marrow-derived circulating progenitor endothelial cells (PEC) (Asahara et al. Science). From thereon, PECs have been extensively studied as potential cell therapy for the repair of damaged blood vessels. Animal studies clearly demonstrated that administration of PECs partially rescued cardiovascular dysfunction or myocardial injury.

Somatic cells can acquire ESC properties through nuclear reprogramming. Three major approaches, including somatic cell nuclear transfer, cell fusion, and forced introduction of defined transcription factors have been established to reprogram somatic cells to pluripotency. The latter approach was first reported by Yamanaka et al. in 2006, who demonstrated that the expression of combined transcription factors, Oct4, Sox2, Klf4 and c-Myc is reprogramming somatic cells into ESC-like cells, termed induced pluripotent stem cells (iPS cells). Since this initial report, the technology has attracted great attention and motivated numerous investigations because of its tremendous potential for regenerative medicine.

Already, iPSCs are a widely accepted advance in stem cell research, as they may allow researchers to obtain pluripotent stem cells for therapeutic application, without the controversial use of embryos. Because iPS cells can be developed from a patient's own somatic cells, it is believed that treatment of iPS cells would avoid immunogenic responses. iPS cells have become an alternative cell source for transplantation.

Stem and progenitor cells as well as induced pluripotent stem cells are thus attractive autologous or allogenic agents for the treatment of malignant and non-malignant hematopoietic and non-hematopoietic disorders.

Product Numbers

PowerStem ESPro1 with LIF ⁽³⁾	500 ml Kit	P04-77010K
PowerStem ESPro1 without LIF ⁽³⁾	500 ml Kit	P04-77510K
PowerStem ESPro2 with LIF ⁽³⁾	500 ml Kit	P04-77020K
PowerStem ESPro2 without LIF ⁽³⁾	500 ml Kit	P04-77620K
PowerStem EST ⁽³⁾	500 ml Kit	P04-77250K
PowerStem HE1 ⁽³⁾	500 ml Kit	P04-77110K
PowerStem HE2 ⁽³⁾	500 ml Kit	P04-77120K
PowerStem iPS1 ⁽³⁾	500 ml Kit	P04-77130K
PowerStem iPS2 ⁽³⁾	500 ml Kit	P04-77140K
PowerStem MSC1 ⁽³⁾	500 ml Kit	P04-77355K
PowerStem HPSC ⁽³⁾	500 ml Kit	P04-77450K
PowerStem PEC1 ready-to-use ⁽³⁾	500 ml	P04-777500
PowerStem PEC1 kit ⁽³⁾	500 ml Kit	P04-77750K

2

PowerStem ESPro1

PowerStem ESPro1 is an easy to use serum-free medium for cultivation of embryonic stem cells of mice (mES cells). These pluripotent cells are derived from blastocysts and they can be established to a permanent cell culture. After injection into blastocysts in chimeras, they can form all tissues, including germ cells. In PowerStem ESPro1, the mES cells largely maintain their undifferentiated state and can be integrated into the germ line.

Composition

PowerStem ESPro1 contains purified proteins, lipids, salts, amino acids, trace elements, attachment factors, hormones and growth factors in an optimized formulation. PowerStem ESPro1 is fully chemically defined and contains no peptones or hydrolysates.

Please note: Supplemented PowerStem ESPro1 contains LIF in a concentration of 10 µg/l. If higher levels of LIF are required for your experimental setting, please add additional LIF to the medium.

Suitability

Serum-free cultivation of embryonic stem cells of mice (mES cells), while maintaining the undifferentiated state. PowerStem ESPro1 is especially designed for the serum-free generation of knockout-mice from genetically modified mES cells. PowerStem ESPro1 has also been proven to support the serum-free cultivation and expansion of tumor progenitor cells.

Special advantages

PowerStem ESPro1 allows the cultivation and expansion of mouse embryonic stem cells (mES cells) under serum-free conditions. It is fully defined in its composition and thus enables constant and comparable experimental conditions resulting in highly reproducible data. The mES cell culture can be established without the usual feeder layer (primary fibroblasts), cells show a high proliferation rate and largely retain an undifferentiated state. By adding specific differentiation factors, mES cells can differentiate in vitro to the desired cell types (e.g. nerve cells, muscle cells, endothelial cells, etc.). Following injection into blastocysts, they can form all tissues in chimeras. Therefore it is possible to generate animals whose genome has been manipulated previously in a cell culture (e.g. knock-out / knock-in mice).

Please note: For differentiation studies LIF supplement must be omitted.

Instructions for use

Detailed instructions will be provided with the accompanying datasheet for PowerStem ESPro1. In addition, instructions for use can also be found at www.pan-biotech.com.

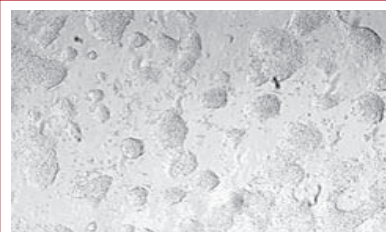

mES-cells in PowerStem ESPro1

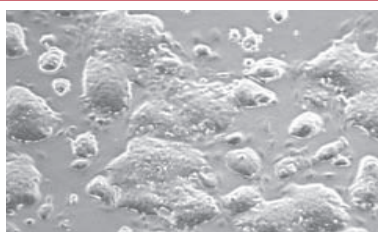

JM8-cells in PowerStem ESPro1



mES-cells in medium with 10% FBS

PowerStem ESPro1 with LIF ⁽³⁾	500 ml Kit	P04-77010K
PowerStem ESPro1 without LIF ⁽³⁾	500 ml Kit	P04-77510K

(1) usually on stock
 (2) minimum order 20 pieces
 (3) available upon request

PowerStem ESPro2

PowerStem ESPro2 is a serum-free medium for cultivation and expansion of embryonic stem cells of mice (mES cells). PowerStem ESPro2 is especially designed to proliferate and expand mES cells without differentiation. To differentiate the proliferated mES cells into different cell types the relevant protocols and differentiation factors can be used.

Composition

PowerStem ESPro2 contains purified proteins, lipids, salts, amino acids, trace elements, attachment factors, hormones and growth factors in an optimized formulation. PowerStem ESPro2 is fully chemically defined and contains no peptones or hydrolysates.

Please note: Supplemented PowerStem ESPro2 contains LIF in a concentration of 10µg/l. If higher levels of LIF are required, please add additional LIF to the medium.

Suitability

PowerStem ESPro2 is especially designed for the serum-free cultivation of murine embryonic stem cells (mES cells), while maintaining the undifferentiated state. PowerStem ESPro2 is suitable for the serum-free generation of knockout-mice from genetically modified mES cells. PowerStem ESPro2 has also been proven to support the serum-free cultivation and expansion of tumor progenitor cells.

Special advantages

PowerStem ESPro2 allows the cultivation and expansion of mouse embryonic stem cells (mES cells) under serum-free conditions. It is fully defined in its composition and thus enables constant and comparable experimental conditions resulting in highly reproducible data. The mES cell culture can be established without the usual feeder layer (primary fibroblasts), cells show a high proliferation rate and largely retain an undifferentiated state. By adding specific differentiation factors, mES cells can differentiate in vitro to the desired cell types (e.g. nerve cells, muscle cells, endothelial cells, etc.).

Instructions for use

Detailed instructions will be provided with the accompanying datasheet for PowerStem ESPro2. In addition, instructions for use can also be found at www.pan-biotech.com.

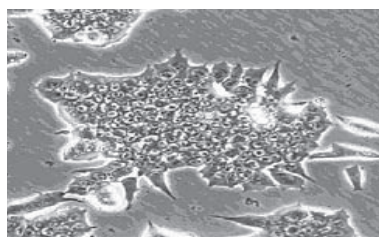

mES-cells in PowerStem ESPro2

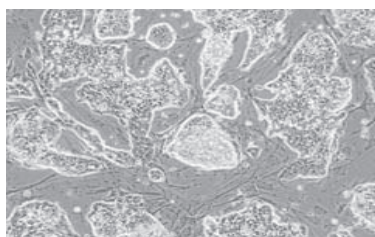

mES-cells in PowerStem ESPro2

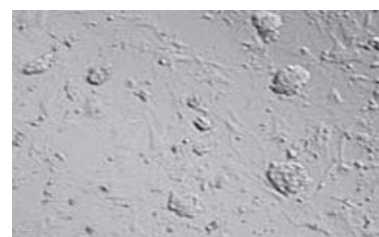

ES-cells in medium with 10% FBS

PowerStem ESPro2 with LIF ⁽³⁾	500 ml Kit	P04-77020K
PowerStem ESPro2 without LIF ⁽³⁾	500 ml Kit	P04-77620K

- (1) usually on stock
- (2) minimum order 20 pieces
- (3) available upon request

PowerStem EST

PowerStem EST is a serum-free system for the cultivation and proliferation of undifferentiated mouse embryonic stem cells (mES cells) and their subsequent differentiation into beating myocardial cells (e.g. for the embryonic stem cell test EST). The EST has been formally validated by the European Centre for Validation of Alternative Methods (ECVAM) as an acceptable in vitro embryotoxicity assay. The in vitro embryonic stem cell test (EST) allows for categorisation of the embryo-toxic potential of chemicals and drug candidates. For the screening process of newly developed chemicals and pharmaceuticals, a prediction model was developed based on the inhibition of differentiation of murine embryonic stem cells into cardiomyocytes.

The application of the EST for chemical testing reduces time, testing costs and the amount of animal experimentation for embryo-toxicity tests.

Composition

PowerStem EST medium kit is composed of a complex basal medium containing salts, amino acids, vitamins, and micronutrients to which a serum-free supplement (PowerStem EST growth supplement) consisting of a mixture of proteins, growth factors and hormones is added immediately prior to use. For sustainment in undifferentiated condition and growth of ES cells, mouse leukemia inhibitory factor (mLIF, 1000 U/ml) is added to the supplemented basal medium (PowerStem EST LIF supplement). For differentiation into beating myocardial cells, a mix of differentiation factors (PowerStem EST differentiation supplement) is added to the supplemented basal medium (without mLIF).

Suitability

Cardiomyocytes differentiated from stem cells can be used for a multitude of purposes:

- Use in basic research for examining early development processes needed for functional cardiogenesis in vitro
- Testing chemicals and pharmaceutical ingredients for mutagenicity, cytotoxicity and embryotoxicity (embryonic stem cell test, EST)
- Screening of anti-angiogenic substances
- Electrophysiological analyses for investigating cardio-active drugs
- Development of new active ingredients

PowerStem EST⁽³⁾

500 ml Kit

P04-77250K

The basal medium is used for both, proliferation and differentiation; defined factors are added according to the objective – sustainment and growth or differentiation of ES cells.

Special advantages

Traditionally, in vitro differentiation of mouse embryonic stem cells takes place using fetal bovine serum (FBS). It has been shown that the use of FBS is a limiting factor for successful differentiation of ES cells into cardiomyocytes. Some batches of FBS result in poor differentiation, while some batches may not allow differentiation at all. The search for suitable FBS batches and the dramatic variability makes the differentiation of ES cells with serum-containing media a time and money consuming exercise.

In contrast, it has been demonstrated that the number of differentiated ES cells is substantially increased under serum-free conditions, and the rate of differentiation is quite stable. The PowerStem EST medium kit successfully stimulates the expansion of undifferentiated ES-cells and promotes their subsequent differentiation into beating myocardial cells under serum-free conditions, resulting in highly comparable findings from standardized experiments.

Instructions for use

Detailed instructions will be provided with the accompanying datasheet for PowerStem EST. In addition, instructions for use can also be found at www.pan-biotech.com.

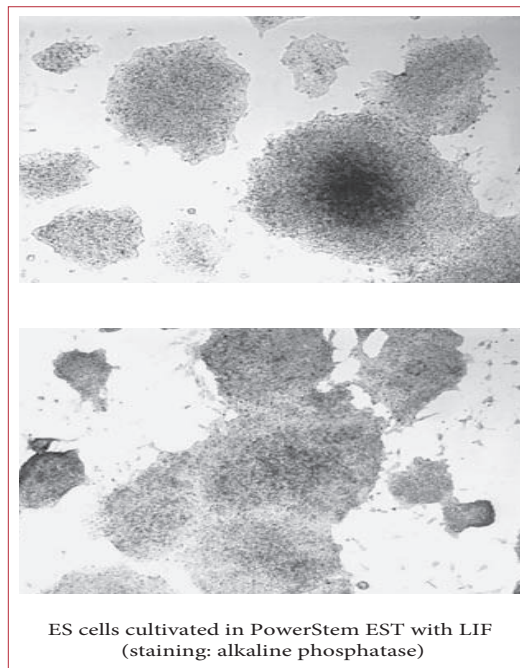

(1) usually on stock

(2) minimum order 20 pieces

(3) available upon request

PowerStem HE1

PowerStem HE1 is a specialized serum-free medium for the cultivation and expansion of human embryonic stem cells (hES cells). Pluripotent human embryonic stem cells have the capacity to differentiate into all of the somatic cell types and therefore hold great promise for regenerative medicine. Even after long-term culture, cells maintained on Matrigel or Laminin retain a normal karyotype and a stable proliferating rate.

PowerStem HE1 basal medium and PowerStem HE1 growth supplement are guaranteed stable for 12 months when properly stored. PowerStem HE1 complete medium (basal + supplement) is stable for 1 month when stored in the dark at 2-8° C. We do not recommend using the complete medium beyond 1 month.

Composition

PowerStem HE1 contains purified proteins, lipids, salts, amino acids, trace elements, attachment factors, hormones and growth factors in an optimized formulation. PowerStem HE1 is fully defined and contains no peptones or hydrolysates.

Please note: PowerStem HE1 contains b-FGF in a concentration of 20 µg/l. If higher b-FGF levels are required, please add additional b-FGF to the medium.

Suitability

Serum-free cultivation of human embryonic stem cells (hES cells), while maintaining an undifferentiated state.

Special advantages

PowerStem HE1 allows the cultivation and expansion of hES cells under serum-free conditions. It is fully defined in its composition and thus enables constant and comparable experimental conditions resulting in highly reproducible data. The hES cells can be cultivated without the usual feeder layers (primary fibroblasts), they show a high proliferation rate and largely retain their undifferentiated state. By adding specific differentiation factors, hES cells can differentiate in vitro to the desired cell types (e.g. nerve cells, muscle cells, endothelial cells, etc.).

Instructions for use

Detailed instructions will be provided with the accompanying datasheet for PowerStem HE1. In addition, instructions for use can also be found at www.pan-biotech.com.

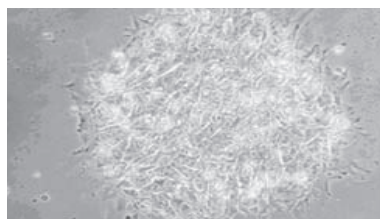

hES-cells in PowerStem HE1

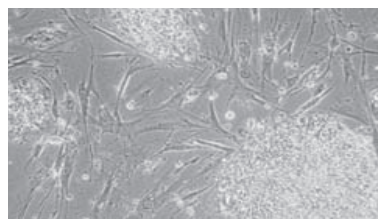

hES-cells colony in PowerStem HE1

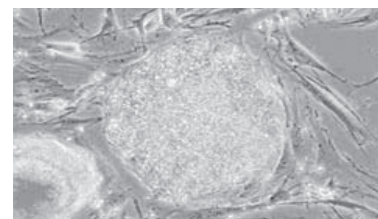

hES-cells in medium with 10 % FBS

PowerStem HE1⁽³⁾

500 ml Kit

P04-77110K

- (1) usually on stock
- (2) minimum order 20 pieces
- (3) available upon request

PowerStem HE2

PowerStem HE2 is a specialized serum-free medium for cultivation and expansion of human embryonic stem cells (hES cells). Pluripotent human embryonic stem cells have the capacity to differentiate into all of the somatic cell types and therefore hold great promise for regenerative medicine. Even after long-term culture, cells maintained on Matrigel or Laminin retain a normal karyotype and a stable proliferating rate.

PowerStem HE2 basal medium and PowerStem HE2 growth supplement are guaranteed stable for 12 months when properly stored. PowerStem HE2 complete medium (basal + supplement) is stable for 1 month when stored in the dark at 2-8° C. We do not recommend using the complete medium beyond 1 month.

Composition

PowerStem HE2 contains purified and recombinant proteins, lipids, salts, amino acids, trace elements, attachment factors, hormones and growth factors in an optimized formulation. PowerStem HE2 is chemically defined and contains no animal-derived components.

Please note: PowerStem HE2 contains b-FGF in a concentration of 2 µg/l. If higher b-FGF levels are required, please add additional b-FGF to the medium.

Suitability

Serum-free cultivation of human embryonic stem cells (hES cells), while maintaining an undifferentiated state.

Special advantages

PowerStem HE2 allows the cultivation and expansion of hES cells under serum-free conditions. It is fully defined in its composition thus enabling constant and comparable experimental conditions resulting in highly reproducible data. The hES cells can be cultivated without the usual feeder layers (primary fibroblasts), they show a high proliferation rate and largely retain their undifferentiated state. By adding specific differentiation factors, hES cells can differentiate in vitro to the desired cell types (e.g. nerve cells, muscle cells, endothelial cells, etc.).

Instructions for use

Detailed instructions will be provided with the accompanying datasheet for PowerStem HE2. In addition, instructions for use can also be found at www.pan-biotech.com.

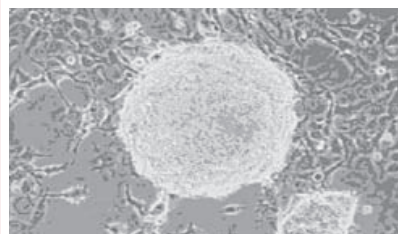

hES-cells in PowerStem HE2

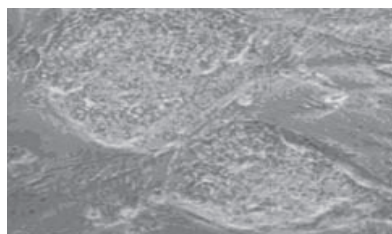

hES-cells in PowerStem HE2

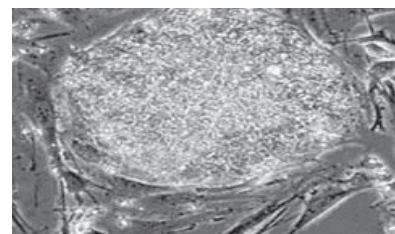

hES-cells in medium with 10 % FBS

PowerStem HE2 ⁽³⁾	500 ml Kit	P04-77120K
------------------------------	------------	------------

- (1) usually on stock
- (2) minimum order 20 pieces
- (3) available upon request

PowerStem iPS1

PowerStem iPS1 is a specialized serum-free medium for the cultivation and expansion of human induced pluripotent stem cells (iPS cells). Induced pluripotent stem cells behave similar to human embryonic stem cells and have the capacity to differentiate into all of the somatic cell types and therefore hold great promise for regenerative medicine. Even after long-term culture (> 50 passages) iPS cells retain a normal karyotype and a stable proliferating rate.

PowerStem iPS1 basal medium and PowerStem iPS1 growth supplement are guaranteed stable for 12 months when properly stored. PowerStem iPS1 complete medium (basal + supplement) is stable for 2 weeks when stored in the dark at 2-8° C. We do not recommend using the complete supplemented medium beyond 2 weeks.

Composition

PowerStem iPS1 contains purified and recombinant proteins, lipids, salts, amino acids, trace elements, hormones and growth factors in an optimized formulation. PowerStem iPS1 is a defined medium and contains no animal- or human-derived substances (except human serum albumin (100 µg/ml) as a stabilizing agent).

Please note: PowerStem iPS1 contains FGF-2 in a high concentration; it is not recommended to add additional FGF-2.

Suitability

Serum-free cultivation of human induced pluripotent stem cells (iPS cells) under defined conditions, while maintaining an undifferentiated state.

Special advantages

PowerStem iPS1 allows the cultivation and expansion of iPS cells under serum-free conditions. It is fully defined in its composition and thus enables constant and comparable experimental conditions resulting in highly reproducible data. The iPS cells can be cultivated without the usual feeder layer of primary fibroblasts, they show a high proliferation rate and largely retain their undifferentiated state. By adding specific differentiation factors, iPS cells can be differentiated in vitro to the desired cell types (e.g. nerve cells, muscle cells, endothelial cells, etc.).

Instructions for use

Detailed instructions will be provided with the accompanying datasheet for PowerStem iPS1. In addition, instructions for use can also be found at www.pan-biotech.com

PowerStem iPS1 ⁽³⁾	500 ml Kit	P04-77130K
-------------------------------	------------	------------

PowerStem iPS2

PowerStem iPS2 is a chemically defined serum-free medium for cultivation and expansion of human induced pluripotent stem cells (iPS cells). Induced pluripotent stem cells behave similar to human embryonic stem cells and have the capacity to differentiate into all of the somatic cell types and therefore hold great promise for regenerative medicine. Even after long-term culture (> 50 passages) iPS cells retain a normal karyotype and a stable proliferating rate.

PowerStem iPS2 basal medium and PowerStem iPS2 growth supplement are guaranteed stable for 12 months when properly stored. PowerStem iPS2 complete medium (basal + supplement) is stable for 1 week when stored in the dark at 2-8° C. We do not recommend using the complete supplemented medium beyond 1 week.

Composition

PowerStem iPS2 contains lipids, salts, amino acids, trace elements, hormones and recombinant growth factors in an optimized formulation. PowerStem iPS2 is chemically defined and contains no animal- or human-derived substances.

Please note: PowerStem iPS2 contains a high concentration FGF-2; it is not recommended to supplement with additional FGF-2.

Suitability

Serum-free cultivation of induced pluripotent stem cells (iPS cells), while maintaining an undifferentiated state.

Special advantages

PowerStem iPS2 allows the cultivation and expansion of iPS cells under serum-free conditions. It is fully defined in its composition thus enabling constant and comparable experimental conditions resulting in highly reproducible data. The iPS cells can be cultivated without the usual feeder layer of primary fibroblasts, they show a high proliferation rate and largely retain their undifferentiated state. By adding specific differentiation factors, iPS cells can be differentiated in vitro to the desired cell types (e.g. nerve cells, muscle cells, endothelial cells, etc.).

Instructions for use

Detailed instructions will be provided with the accompanying datasheet for PowerStem iPS2. In addition, instructions for use can also be found at www.pan-biotech.com

PowerStem iPS2 ⁽³⁾	500 ml Kit	P04-77140K
-------------------------------	------------	------------

- (1) usually on stock
 (2) minimum order 20 pieces
 (3) available upon request

PowerStem MSC1

PowerStem MSC1 is an easy to use xeno-free medium without animal derived components (ADCF) for cultivation and proliferation of human mesenchymal stem cells (hMSC). PowerStem MSC1 is especially designed for the proliferation of human mesenchymal stem cells without differentiation. PowerStem MSC1 supports long-term growth of MSC and preserves their multi-lineage potential. In addition, MSC cultured in PowerStem MSC1 expands faster and shows a significant reduction in hematopoietic cell contamination at early passages compared to serum-based media. To differentiate the proliferated MSC into different cells types the relevant protocols and differentiation factors should be used.

Composition

PowerStem MSC1 contains salts, amino acids, trace elements, hormones, growth factors, and enriched human proteins and lipids in an optimized formulation. PowerStem MSC1 is free of animal derived components (ADCF, xenofree) and contains no undefined peptones or hydrolysates.

PowerStem MSC1 500ml Kit consists of:

- PowerStem MSC1 basal medium
- PowerStem MSC1 growth supplement 1
- PowerStem MSC1 growth supplement 2

Stability

- PowerStem MSC1 basal medium: store in the dark at 2-8° C
- 2 PowerStem MSC1 growth supplements: store in the dark at -20° C (will be shipped on dry ice, should be used immediately on arrival or may be refrozen for later use)

PowerStem MSC1 basal medium is stable for 2 years and PowerStem MSC1 growth supplements are guaranteed stable for 12 months when properly stored. PowerStem MSC1 complete medium (basal + supplements) is stable for 6 weeks when stored in the dark at 2-8° C. We do not recommend using the supplemented complete medium beyond 6 weeks. Do not freeze complete PowerStem MSC1 medium.

Suitability

Serum-free cultivation of human mesenchymal stem cells (hMSC) while maintaining the undifferentiated state and multi-lineage potential.

Special advantages

PowerStem MSC1 allows the cultivation of human mesenchymal stem cells under xeno-free conditions. It is free of animal serum and thus enables constant and comparable experimental conditions resulting in highly reproducible data. PowerStem MSC1 is completely free of animal components (ADCF, xeno-free) and thus suitable for a research approach in regenerative medicine and tissue engineering. By adding specific differentiation factors, MSC can differentiate in vitro to the desired cell types (bone, cartilage, adipose tissue etc.).

Instructions for use

Detailed instructions can be found at www.pan-biotech.com. For more instructions please see instruction manual for isolation and culture of hMSC.

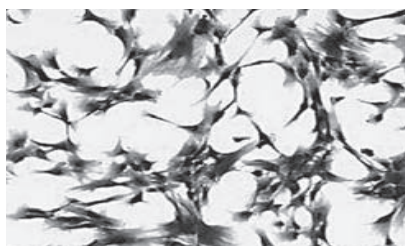

Sub-confluent hMSC in PowerStem MSC1

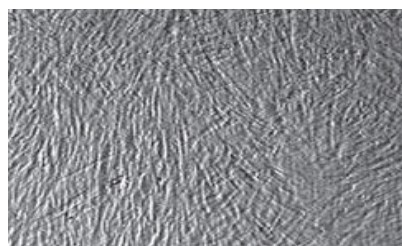

Confluent hMSC in PowerStem MSC1

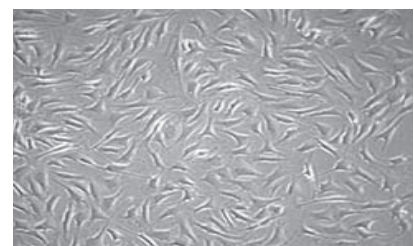

hMSC in medium with 10% FBS

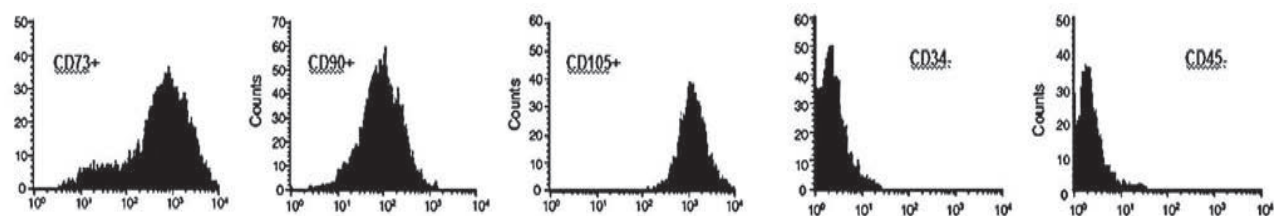

The culture-expanded cell population expresses CD90 (Thy-1), CD105 (SH2) and CD73 (SH3/SH4) but lacks expression of CD34 and CD45.

PowerStem MSC1⁽³⁾

500 ml Kit

P04-77355K

- (1) usually on stock
- (2) minimum order 20 pieces
- (3) available upon request

PowerStem HPSC

PowerStem HPSC is a specialized serum-free medium for the cultivation and expansion of human hematopoietic stem cells (HPSC) and cells of myeloid lineage in suspension culture. Hematopoietic stem cells are CD34+, which are the earliest hematopoietic stem cells identifiable in bone marrow, peripheral blood and neonatal cord blood. By adding one or more differentiation factors or changing culturing conditions, HPSC can be induced to differentiate into different types of hematopoietic lineage cells.

PowerStem HPSC basal medium, PowerStem HPSC growth supplement and PowerStem HPSC cytokine supplement are guaranteed stable for 12 months when properly stored. PowerStem HPSC complete medium (basal + supplements) is stable for 3 months when stored in the dark at 2-8° C. We do not recommend using the complete medium beyond 3 months.

Composition

~~PowerStem HPSC contains purified proteins, lipids, salts, amino acids, trace elements, attachment factors, hormones and growth factors in an optimized formulation. PowerStem HPSC is fully defined and contains no FBS.~~

Suitability

Serum-free cultivation and expansion of human hematopoietic CD34+ stem cells from bone marrow, peripheral blood and neonatal cord blood.

Special advantages

PowerStem HPSC allows the cultivation and expansion of human hematopoietic CD34+ stem cells and cells of myeloid lineage under serum-free conditions. It is fully defined in its composition and thus enables constant and comparable experimental conditions with easily reproducible results. The hematopoietic stem cells can be cultivated without stromal cells, they show a high proliferation rate and largely retain their undifferentiated state. By adding specific differentiation factors, hematopoietic cells can be differentiated in vitro to different types of hematopoietic lineage cells.

Instructions for use

Detailed instructions will be provided with the accompanying datasheet for PowerStem HPSC. In addition, instructions for use can also be found at www.pan-biotech.com.

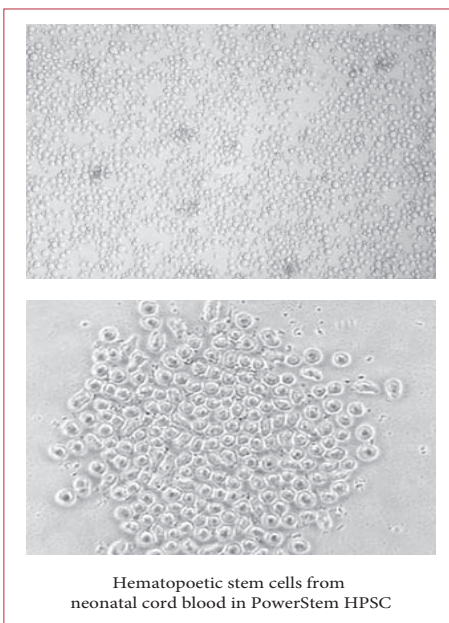

References

Horschitz S et al. (2010) Generation of neuronal cells from human peripheral blood mononuclear cells. *Neuro Report* 21:185.

PowerStem HPSC ⁽³⁾	500 ml Kit	P04-77450K
-------------------------------	------------	------------

- (1) usually on stock
- (2) minimum order 20 pieces
- (3) available upon request

PowerStem PEC1

Endothelial cells line blood vessels and the internal cavities of the heart. They display a flattened, polygonal form and adhere to each other by desmosomes and tight-junctions. With a total number of about 10^{12} cells, the endothelium is one of the biggest organs of the body and plays a key role in many physiological and pathophysiological processes. A number of factors control proliferation and apoptosis of endothelial cells, thereby regulating maintenance, degeneration, or regeneration of blood vessels.

New blood vessel formation occurs via angiogenesis or vasculogenesis, a process restricted to embryonic development. In 1997, postnatal vasculogenesis has been proposed as an important mechanism for angiogenesis via blood or bone marrow derived circulating progenitor endothelial cells (PEC) (Asahara et al. Science 1997). PEC have been extensively studied as potential cell therapy for the repair of damaged blood vessels. Animal studies clearly demonstrated that administration of PEC partially rescued cardiovascular dysfunction or myocardial injury with evidence for PEC contribution to new vessel growth.

While controversy exists as to the identity of endothelial cell progenitors, recently a PEC population has been identified which shows expression of typical endothelial as well as progenitor markers (Ingram et al. Blood. 2004;104:2752-2760). Importantly, these cells have been tested for a high proliferative potential in clonogenic assays and characterized by formation of functional blood vessels *in vivo* (Yoder et al. Blood. 2007;109:1801-1809).

With endothelial cell progenitors rapidly moving into the field of interest for vascular tissue engineering with potential therapeutic application, the presence of whole animal serum or animal-derived components in culture media is undesirable for a cell therapeutic approach.

Description

PowerStem PEC1 ready-to-use (P04-777500) is a specially developed medium for a serum- and xeno-free *in vitro* culture of human progenitor endothelial cells (hPEC) containing all components necessary for optimal colony formation, clonogenic growth, and rapid proliferation. It is designed for use in an incubator at 37° C with a 5% CO₂ atmosphere.

PowerStem PEC1 kit (P04-77750K) is provided with supplements (pre-screened and tested for progenitor cells) in separate sterile packing. This will enable the user to prepare a medium for special application. For example, VEGF, FGF-2, or other components may be omitted from the complete medium for specific experimental settings. Please note that such a formulation will not promote optimal cell growth. Therefore, this composition can not be used for routine long-term culture of PEC. Please make sure that sterility is not compromised when adding individual components to prepare complete medium. The medium should be carefully but thoroughly mixed after addition of all components to assure a homogeneous solution. Store basal or complete medium at 2 – 8° C and store supplements at -20° C. Expiry: 1 year.

Basal medium (w/o supplements) or complete/ready-to-use medium should not be frozen!

Instructions for use

Detailed instructions will be provided with the accompanying datasheet for PowerStem PEC1. In addition, instructions for use can also be found at www.pan-biotech.com.

References

- a) Asahara T et al. (1997) Isolation of putative progenitor endothelial cells for angiogenesis. Science 275:964
- b) Ingram DA et al. (2004) Identification of a novel hierarchy of endothelial progenitor cells using human peripheral and umbilical cord blood. Blood 104:2752
- c) Yoder MC et al. (2007) Redefining endothelial progenitor cells via clonal analysis and hematopoietic stem/progenitor cell principals. Blood 109:1801

PowerStem PEC1 ready-to-use ⁽³⁾	500 ml	P04-777500
PowerStem PEC1 kit	500 ml Kit	P04-77750K

- (1) usually on stock
- (2) minimum order 20 pieces
- (3) available upon request

Media

Introduction	61	MEM with Earle's Salts	91
Alpha MEM	62	MEM with Hank's Salts	93
BME with Earle's Salts	64	RPMI 1640	94
BME with Hank's Salts	64	Schneider's Drosophila Medium	97
CMRL-1066 Medium	65	TC 100 Insect Medium	98
Dulbecco's Modified Eagle Medium	66	TNM-FH Medium	99
DMEM / F12	72	Waymouth's MB 752/1 Medium	100
Glasgow MEM (BHK21)	74	William's Medium E	101
Grace's Insect Medium	75	Endopan 3	102
Ham's F10 Medium	76	Endopan MV	102
Ham's F12 Medium	77	Endopan PRO	103
Iscove's Modified Dulbecco's Medium	79	Pantum	104
IPL-41 Insect Medium	82	Neuropan	104
Joklik-MEM	83	Stempan	105
Leibovitz's L-15 Medium	84	Mesenpan	105
McCoy's 5A Medium	86	EMEM Fibroblasts	105
MCDB 131 Medium	88	Amniopan	106
Medium 199 with Earle's Salts	89	Amniopan S2	106
Medium 199 with Hank's Salts	90	Amniopan III	106
		Marrowpan	107
		Marrowpan S2	107



Introduction

You only want highest quality media for cell cultivation?

At PAN-Biotech, perfect raw materials combined with state-of-the-art technologies guarantee a first-class quality of our media.

Water is the most important component of liquid media, which is why water purity is of outstanding importance for the quality of media. The water we use generally has a very low endotoxin level of < 0.005 EU/ml, and therefore is of highest purity.

Our media are placed in quarantine until quality control procedures are finished. This guarantees an excellent quality of the final product.

Advantages of our cell culture media

- Raw materials used are tested according to the highest possible quality standards
- Standard filling in sterile, high-class PET bottles
- Batches of 10 litres up to 2000 litres
- Custom service of product optimisation and further development for specific applications and purposes
- CE-label according to medical product law available upon request

Other sizes and custom formulation

Almost all media available from PAN-Biotech can be filled in special containers as per customer requirement. Besides standard bottles in 100, 500, and 1000 ml, medium can be filled in cans (up to 10 L), bags (up to 500 L), or other containers with fittings according to customer specifications for special applications such as continuous feed process or production purposes.

Delivery time

Standard media:

In principle within 3 working days in Germany; otherwise we will inform you.

Special media and custom products:

Within Germany in 4 to 6 weeks after receipt of order.

Shelf life

Powder media	2 years
Liquid media without Glutamine	2 years
Liquid media with stable Glutamine	2 years
Liquid media with L-Glutamine	1 year

Liquid media with L-Glutamine can be used also after the expiry date, but have to be supplemented with new L-Glutamine in this case. Shelf life starts on date of production!

Storage

Powder media	2 – 8° C
Liquid media	2 – 8° C protected from light

Benefit from the experience and know-how of PAN-Biotech. Our state-of-the-art production facilities, with a production line specifically installed for these requirements, allow us to produce the formulations especially developed for your needs in constant high quality also for longer periods of time, and to make batch sizes adapted to your needs. Our team of scientists will be pleased to advise you regarding your proprietary formulation.

For further information regarding the dependency of ph-values in media on the CO₂ concentration in the incubator please refer to our website at www.pan-biotech.com.

Alpha MEM

Description

Alpha MEM is a different formulation of MEM Eagle and contains a higher concentration of amino acids. It also has a higher concentration of lipoic acid, vitamins and pyruvate. Primarily it was developed for the cultivation of hamster kidney cells, but today it is used for a broad range of mammalian cells. Among others the alpha MEM promotes the growth and progeny of bone marrow cells in suspension culture and monolayer. A further possibility is the use as a separation medium or for the out-breeding of amniotic cells.

Liquid Media

Alpha MEM Eagle⁽¹⁾
without L-Glutamine
without Ribonucleosides
without Deoxyribonucleosides
with 2.2 g/L NaHCO₃ 500 ml P04-21050

Alpha MEM Eagle⁽¹⁾
with L-Glutamine
with Ribonucleosides
with Deoxyribonucleosides
with 2.2 g/L NaHCO₃ 500 ml P04-21500

Alpha MEM Eagle⁽¹⁾
with stable Glutamine
with Ribonucleosides
with Deoxyribonucleosides
with 2.2 g/L NaHCO₃ 500 ml P04-21250

Alpha MEM Eagle⁽¹⁾
with L-Glutamine
without Ribonucleosides
without Deoxyribonucleosides
with 2.2 g/L NaHCO₃ 500 ml P04-21060

Alpha MEM Eagle⁽¹⁾
with stable Glutamine
without Ribonucleosides
without Deoxyribonucleosides
with 2.2 g/L NaHCO₃ 500 ml P04-21350

Special Media

Alpha MEM Eagle⁽²⁾
without L-Glutamine
with Ribonucleosides
with Deoxyribonucleosides
with 2.2 g/L NaHCO₃ 500 ml P04-21150

Alpha MEM Eagle⁽²⁾
with L-Glutamine
without Glucose
with Ribonucleosides
with Deoxyribonucleosides
with 2.2 g/L NaHCO₃ 500 ml P04-21502

Alpha MEM Eagle⁽²⁾
without L-Glutamine
without Phenol red
without Ribonucleosides
without Deoxyribonucleosides
with 2.2 g/L NaHCO₃ 500 ml P04-21051

Table for Alpha MEM

	L-Glutamine	Stable Glutamine	Ribonucleosides	Deoxyribonucleosides	Special
P04-21050					
P04-21500	x		x	x	
P04-21250		x	x	x	
P04-21060	x				
P04-21350		x			
P04-21150			x	x	See above
P04-21502	x		x	x	See above
P04-21051					See above

- (1) usually on stock
(2) minimum order 20 pieces
(3) available upon request

Alpha MEM

Powder Media

Alpha MEM Eagle ⁽¹⁾ without L-Glutamine with Ribonucleosides with Deoxyribonucleosides without NaHCO ₃	10 L P03-2410 50 L P03-2450
Alpha MEM Eagle ⁽¹⁾ with L-Glutamine with Ribonucleosides with Deoxyribonucleosides without NaHCO ₃	10 L P03-2510 50 L P03-2550
Alpha MEM Eagle ⁽¹⁾ with L-Glutamine without Ribonucleosides without Deoxyribonucleosides without NaHCO ₃	10 L P03-2310 50 L P03-2350
Alpha MEM Eagle ⁽¹⁾ with L-Glutamine with 25 mM HEPES with Ribonucleosides with Deoxyribonucleosides without NaHCO ₃	10 L P03-2610 50 L P03-2650

Composition

	Components	mg/L
Inorganic Salts	Calcium chloride x 2H ₂ O	264.92
	Magnesium sulfate anhydrous	97.67
	Potassium chloride	400.00
	Sodium chloride	6,800.00
	Sodium dihydrogen phosphate x H ₂ O	140.00
Other Components	D(+)-Glucose anhydrous	1,000.00
	HEPES	5,958.00
	Lipoic acid	0.20
	Phenol red	10.00
	Sodium pyruvate	110.00
Amino Acids	L-Alanine	25.00
	L-Arginine x HCl	126.64
	L-Asparagine x H ₂ O	50.00
	L-Aspartic acid	30.00
	L-Cysteine x HCl x H ₂ O	100.00
	L-Cystine	24.00
	L-Glutamine	292.00
	L-Glutamic acid	75.00
	Glycine	50.00
	L-Histidine x HCl x H ₂ O	42.00
	L-Isoleucine	52.40
	L-Leucine	52.40
	L-Lysine x HCl	72.47
	L-Methionine	15.00
	L-Phenylalanine	32.00
	L-Proline	40.00
	L-Serine	25.00
	L-Threonine	48.00
	L-Tryptophan	10.00
L-Tyrosine	36.20	
L-Valine	46.00	
Vitamins	L-Ascorbic acid	50.00
	D(+)-Biotin	0.10
	D-Calcium pantothenate	1.00
	Choline chloride	1.00
	Folic acid	1.00
	myo-Inositol	2.00
	Nicotinamide	1.00
	Pyridoxal x HCl	1.00
	Riboflavin	0.10
	Thiamine x HCl	1.00
	Vitamine B12	1.33
Ribonucleosides	Adenosine	10.00
	Cytidine	10.00
	Guanosine	10.00
	Uridine	10.00
Deoxyribonucleosides	2'-Deoxyadenosine x H ₂ O	10.00
	2'-Deoxycytidine x HCl	11.00
	2'-Deoxyguanosine	10.00
	2'-Deoxythymidine	10.00

If 5,958.00 mg/L HEPES are included there are only 6,300.00 mg/L sodium chloride.

- (1) usually on stock
 (2) minimum order 20 pieces
 (3) available upon request

BME with Hank`s Salts

Description

In the fifties of the last century it was found that mammalian cells do not only need the 10 essential amino acids, but also cystine, tyrosine and glutamine. In addition to these three amino acids BME includes

Composition

	Components	mg/L
Inorganic Salts	Calcium chloride x 2H ₂ O	185.44
	Magnesium sulfate anhydrous	97.67
	Potassium chloride	400.00
	Potassium dihydrogen phosphate anhydrous	60.00
	Sodium chloride	8,000.00
	di-Sodium hydrogen phosphate	47.88
	Other Components	D(+)-Glucose anhydrous
	Phenol red	10.00
Amino Acids	L-Arginine x HCl	21.00
	L-Cystine	12.00
	L-Glutamine	292.00
	L-Histidine base	8.00
	L-Isoleucine	26.00
	L-Leucine	26.00
	L-Lysine x HCl	36.47
	L-Methionine	7.50
	L-Phenylalanine	16.50
	L-Threonine	24.00
	L-Tryptophan	4.00
	L-Tyrosine	18.00
	L-Valine	23.50
Vitamins	D(+)-Biotin	1.00
	D-Calcium pantothenate	1.00
	Choline chloride	1.00
	Folic acid	1.00
	myo-Inositol	2.00
	Nicotinamide	1.00
	Pyridoxal x HCl	1.00
	Riboflavin	0.10
	Thiamine x HCl	1.00

Liquid Media

BME with HBSS⁽¹⁾
without L-Glutamine
with 0.35 g/L NaHCO₃ 500 ml P04-26050

BME with Earle`s Salts

also eight B-vitamins. Originally BME was used for the cultivation of murine L-cells and HeLa cells. With its many variations it is used in many fields of science today. Along with the cultivation of normal mammalian cells BME is very suitable for transformed cells.

Composition

	Components	mg/L
Inorganic Salts	Calcium chloride x 2H ₂ O	264.92
	Magnesium sulfate anhydrous	97.67
	Potassium chloride	400.00
	Sodium chloride	6,800.00
	Sodium dihydrogen phosphate x H ₂ O	140.00
	Other Components	D(+)-Glucose anhydrous
	Phenol red	10.00
Amino Acids	L-Arginine x HCl	21.00
	L-Cystine	12.00
	L-Glutamine	292.00
	L-Histidine base	8.00
	L-Isoleucine	26.00
	L-Leucine	26.00
	L-Lysine x HCl	36.47
	L-Methionine	7.50
	L-Phenylalanine	16.50
	L-Threonine	24.00
	L-Tryptophan	4.00
L-Tyrosine	18.00	
L-Valine	23.50	
Vitamins	D(+)-Biotin	1.00
	D-Calcium pantothenate	1.00
	Choline chloride	1.00
	Folic acid	1.00
	myo-Inositol	2.00
	Nicotinamide	1.00
	Pyridoxal x HCl	1.00
	Riboflavin	0.10
	Thiamine x HCl	1.00

Liquid Media

BME with EBSS⁽¹⁾
without L-Glutamine
with 2.2 g/L NaHCO₃ 500 ml P04-25050

Special Media

BME with EBSS⁽²⁾
with L-Glutamine
with 2.2 g/L NaHCO₃ 500 ml P04-25500

- (1) usually on stock
(2) minimum order 20 pieces
(3) available upon request

CMRL-1066 Medium

Description

The CMRL is a nucleosid- and vitamin-rich medium. In the past it was developed to clone monkey-kidney cells and as long time culture medium for L-cells. It is suitable for many types of human and monkey cells and also for other mammalian cells, especially by using horse and calf serum.

Liquid Media

CMRL – 1066⁽¹⁾
without L-Glutamine
without Phenol red
with 2.2 g/L NaHCO₃ 500 ml P04-84600

Special Media

CMRL – 1066⁽²⁾
with L-Glutamine
without Phenol red
with 2.2 g/L NaHCO₃ 500 ml P04-84500

Composition

	Components	mg/L
Inorganic Salts	Calcium chloride x 2H ₂ O	264.92
	Potassium chloride	400.00
	Magnesium sulfate anhydrous	97.67
	Sodium acetate anhydrous	50.00
	Sodium chloride	6,800.00
	Sodium dihydrogen phosphate x H ₂ O	140.00
	Other Components	Cholesterol
D(+)-Glucose anhydrous		1,000.00
Glutathione (red.)		10.00
Sodium glucuronate x H ₂ O		3.88
Tween 80		5.00
Coenzyme	Coccarboxylase x HCl	1.00
	Coenzyme A Trilithiumsalt x 2H ₂ O	2.60
	NAD	7.00
	NADP sodium salt	1.00
	UTP	1.00

Composition

Amino Acids	L-Alanine	25.00
	L-Arginine x HCl	70.00
	L-Aspartic acid	30.00
	L-Cysteine x HCl x H ₂ O	260.00
	L-Cystine	20.00
	L-Glutamine	100.00
	L-Glutamic acid	75.00
	Glycine	50.00
	L-Histidine x HCl x H ₂ O	20.00
	L-Hydroxyproline	10.00
	L-Isoleucine	20.00
	L-Leucine	60.00
	L-Lysine x HCl	70.00
	L-Methionine	15.00
	L-Phenylalanine	25.00
	L-Proline	40.00
	L-Serine	25.00
L-Threonine	30.00	
L-Tryptophan	10.00	
L-Tyrosine	40.00	
L-Valine	25.00	
Vitamins	L-Ascorbic acid	50.00
	P-Aminobenzoic Acid	0.05
	D(+)-Biotin	0.01
	D-Calcium pantothenate	0.01
	Choline chloride	0.50
	Folic acid	0.01
	myo-Inositol	0.05
	Nicotinic Acid	0.025
	Nicotinamide	0.025
	Pyridoxal x HCl	0.025
	Pyridoxine	0.025
Riboflavin	0.01	
Thiamine x HCl	0.01	
Deoxy-ribonucleosides	2'-Deoxyadenosine x H ₂ O	10.00
	2'-Deoxycytidine x HCl	11.00
	2'-Deoxyguanosine	10.00
	2'-Deoxythymidine	10.00
	5-Methyl-2'-deoxycytidine	0.10
	Flavin adenine dinucleotide Na ₂ - Salt	0.106

(1) usually on stock

(2) minimum order 20 pieces

(3) available upon request

Dulbecco's Modified Eagle Medium

Description

Intrinsically developed for the cultivation of murine embryonic cells, DMEM is tailor-made for the cultivation of a broad range of cells, especially if the medium is supplemented with FBS. DMEM is an Eagle medium modification with a four-fold content of amino acids and vitamins. DMEM with 1.0 g/L Glucose is the standard medium, whereas DMEM with 4.5 g/L Glucose is for cells which have a high energy demand.

Liquid Media without Glucose

DMEM without Glucose⁽¹⁾
without L-Glutamine
without Sodium pyruvate
with 3.7 g/L NaHCO₃ 500 ml P04-01548S1

DMEM without Glucose⁽¹⁾
without L-Glutamine
with Sodium pyruvate
with 3.7 g/L NaHCO₃ 500 ml P04-01549

DMEM without Glucose⁽¹⁾
without L-Glutamine
without Sodium pyruvate
without Phenol red
with 3.7 g/L NaHCO₃ 500 ml P04-01548

Special Media without Glucose

DMEM without Glucose⁽²⁾
with L-Glutamine
with Sodium pyruvate
with 3.7 g/L NaHCO₃ 500 ml P04-01551

Powder Media without Glucose

DMEM without Glucose⁽¹⁾
without L-Glutamine
without Sodium pyruvate
without Phenol red 10 L P03-0010
without NaHCO₃ 50 L P03-0050

Liquid Media with 1.0 g/L Glucose

DMEM with 1.0 g/L Glucose⁽¹⁾
without L-Glutamine
with Sodium pyruvate
without Phenol red
with 3.7 g/L NaHCO₃ 500 ml P04-01159

DMEM with 1.0 g/L Glucose⁽¹⁾
without L-Glutamine
with Sodium pyruvate
with 3.7 g/L NaHCO₃ 500 ml P04-01500

DMEM with 1.0 g/L Glucose⁽¹⁾
with L-Glutamine
with Sodium pyruvate
with 3.7 g/L NaHCO₃ 500 ml P04-01550

DMEM with 1.0 g/L Glucose⁽¹⁾
with stable Glutamine
with Sodium pyruvate
with 3.7 g/L NaHCO₃ 500 ml P04-02500

DMEM with 1.0 g/L Glucose⁽¹⁾
with L-Glutamine
with Sodium pyruvate
without Phenol red
with 3.7 g/L NaHCO₃ 500 ml P04-01515

DMEM with 1.0 g/L Glucose⁽¹⁾
with L-Glutamine
with Sodium pyruvate
with 25 mM HEPES
with 3.7 g/L NaHCO₃ 500 ml P04-05551

DMEM with 1.0 g/L Glucose⁽¹⁾
with stable Glutamine
with Sodium pyruvate
without Phenol red
with 3.7 g/L NaHCO₃ 500 ml P04-02500S1

Powder Media with 1.0 g/L Glucose

DMEM with 1.0 g/L Glucose⁽¹⁾
with L-Glutamine
with Sodium pyruvate 10 L P03-0510
without NaHCO₃ 50 L P03-0550

DMEM with 1.0 g/L Glucose⁽¹⁾
with L-Glutamine
with Sodium pyruvate
without Phenol red 10 L P03-01510
without NaHCO₃ 50 L P03-01550

(1) usually on stock

(2) minimum order 20 pieces

(3) available upon request

Dulbecco`s Modified Eagle Medium

Special Media with 1.0 g/L Glucose

DMEM with 1.0 g/L Glucose⁽²⁾
without L-Glutamine
with Sodium pyruvate
without Calcium
with 3.7 g/L NaHCO₃ 500 ml P04-01501

DMEM with 1.0 g/L Glucose⁽²⁾
with stable Glutamine
with Sodium pyruvate
with 2.2 g/L NaHCO₃ 500 ml P04-01504

SILAC-DMEM⁽²⁾
with 1.0 g/L Glucose
with stable Glutamine
with Sodium pyruvate
without L-Arginine
without L-Lysine
with 3.7 g/L NaHCO₃ 500 ml P04-02501

DMEM with 1.0 g/L Glucose⁽²⁾
without L-Glutamine
without Sodium pyruvate
without Phenol red
with 3.7 g/L NaHCO₃ 500 ml P04-03556

DMEM with 1.0 g/L Glucose⁽²⁾
with L-Glutamine
without Sodium pyruvate
without Phenol red
with 3.7 g/L NaHCO₃ 500 ml P04-01516

DMEM with 1.0 g/L Glucose⁽²⁾
with L-Glutamine
without Sodium pyruvate
with 3.7 g/L NaHCO₃ 500 ml P04-01555

Liquid Media with 4.5 g/L Glucose

DMEM with 4.5 g/L Glucose⁽¹⁾
without L-Glutamine
without Sodium pyruvate
with 3.7 g/L NaHCO₃ 500 ml P04-03500

DMEM with 4.5 g/L Glucose⁽¹⁾
without L-Glutamine
with Sodium pyruvate
with 3.7 g/L NaHCO₃ 500 ml P04-03600

DMEM with 4.5 g/L Glucose⁽¹⁾
with L-Glutamine
without Sodium pyruvate
with 3.7 g/L NaHCO₃ 500 ml P04-03550

DMEM with 4.5 g/L Glucose⁽¹⁾
with L-Glutamine
with Sodium pyruvate
with 3.7 g/L NaHCO₃ 500 ml P04-03590

DMEM with 4.5 g/L Glucose⁽¹⁾
with L-Glutamine
with Sodium pyruvate
with 1.5 g/L NaHCO₃ 500 ml P04-03596

DMEM with 4.5 g/L Glucose⁽¹⁾
with stable Glutamine
without Sodium pyruvate
with 3.7 g/L NaHCO₃ 500 ml P04-04500

DMEM with 4.5 g/L Glucose⁽¹⁾
with stable Glutamine
with Sodium pyruvate
with 3.7 g/L NaHCO₃ 500 ml P04-04510

DMEM with 4.5 g/L Glucose⁽¹⁾
without L-Glutamine
without Sodium pyruvate
without Phenol red
with 3.7 g/L NaHCO₃ 500 ml P04-01161

DMEM with 4.5 g/L Glucose⁽¹⁾
without Glutamine
with Sodium pyruvate
without Phenol red
with 3.7 g/L NaHCO₃ 500 ml P04-01158

DMEM with 4.5 g/L Glucose⁽¹⁾
with L-Glutamine
with Sodium pyruvate
without Phenol red
with 3.7 g/L NaHCO₃ 500 ml P04-03591

(1) usually on stock

(2) minimum order 20 pieces

(3) available upon request

Dulbecco's Modified Eagle Medium

DMEM with 4.5 g/L Glucose⁽¹⁾
with L-Glutamine
with 25 mM HEPES
without Sodium pyruvate
with 3.7 g/L NaHCO₃ 500 ml P04-05540

DMEM with 4.5 g/L Glucose⁽¹⁾
with L-Glutamine
with 25 mM HEPES
with Sodium pyruvate
with 3.7 g/L NaHCO₃ 500 ml P04-05550

DMEM with 4.5 g/L Glucose⁽¹⁾
with stable Glutamine
with Sodium pyruvate
without Phenol red
with 3.7 g/L NaHCO₃ 500 ml P04-03588

Special Media with 4.5 g/L Glucose

DMEM with 4.5 g/L Glucose⁽²⁾
with stable L-Glutamine
with 25 mM HEPES
without Sodium pyruvate
with 3.7 g/L NaHCO₃ 500 ml P04-04550

DMEM with 4.5 g/L Glucose⁽²⁾
with L-Glutamine
without Sodium pyruvate
with 25 mM HEPES
without Phenol red
with 3.7 g/L NaHCO₃ 500 ml P04-05545

DMEM with 4.5 g/L Glucose⁽²⁾
without L-Glutamine
with 25 mM HEPES
with Sodium pyruvate
with 3.7 g/L NaHCO₃ 500 ml P04-01597

DMEM with 4.5 g/L Glucose⁽²⁾
with L-Glutamine
with Sodium pyruvate
without L-Arginine
with 3.7 g/L NaHCO₃ 500 ml P04-03598

DMEM with 4.5 g/L Glucose⁽²⁾
with L-Glutamine
with 25 mM HEPES
without Sodium pyruvate
with 2.2 g/L NaHCO₃ 500 ml P04-04057

DMEM with 4.5 g/L Glucose⁽²⁾
with L-Glutamine
without Sodium pyruvate
without Sodium chloride
without NaHCO₃ 500 ml P04-03560

DMEM with 4.5 g/L Glucose⁽²⁾
with stable Glutamine
with Sodium pyruvate
with 25 mM HEPES
without Phenol red
with 0.5 g/L NaHCO₃ 500 ml P04-01163

DMEM with 4.5 g/L Glucose⁽²⁾
without L-Glutamine
without Sodium pyruvate
without L-Isoleucine
with 3.7 g/L NaHCO₃ 500 ml P04-03503

Special Media with 5.5 g/L Glucose

DMEM with 5.5 g/L Glucose⁽²⁾
with L-Glutamine
without Sodium pyruvate
with 3.7 g/L NaHCO₃ 500 ml P04-03551

(1) usually on stock
(2) minimum order 20 pieces
(3) available upon request

Dulbecco's Modified Eagle Medium

Powder Media with 4.5 g/L Glucose

DMEM with 4.5 g/L Glucose ⁽¹⁾ without L-Glutamine		
without Sodium pyruvate	10 L	P03-6510
without NaHCO ₃	50 L	P03-6550
DMEM with 4.5 g/L Glucose ⁽¹⁾ with L-Glutamine		
without Sodium pyruvate	10 L	P03-0710
without NaHCO ₃	50 L	P03-0750
DMEM with 4.5 g/L Glucose ⁽¹⁾ with L-Glutamine		
with Sodium pyruvate	10 L	P03-0810
without NaHCO ₃	50 L	P03-0850
DMEM with 4.5 g/L Glucose ⁽¹⁾ with L-Glutamine		
without Sodium pyruvate		
with 25 mM HEPES	10 L	P03-0910
without NaHCO ₃	50 L	P03-0950
DMEM with 4.5 g/L Glucose ⁽¹⁾ with L-Glutamine		
with Sodium pyruvate		
with 25 mM HEPES	10 L	P03-1010
without NaHCO ₃	50 L	P03-1050

Composition

	Components	mg/L
Inorganic Salts	Calcium chloride anhydrous	200.00
	Iron(III) nitrate x 9H ₂ O	0.10
	Magnesium sulfate anhydrous	97.66
	Potassium chloride	400.00
	Sodium chloride	6,400.00
	Sodium dihydrogen phosphate anhydrous	108.69
Other Components	D(+)-Glucose anhydrous	4,500.00
	HEPES	5,958.00
	Phenol red	15.00
	Sodium pyruvate	110.00
Amino Acids	L-Arginine x HCl	84.00
	L-Cystine x 2HCl	62.58
	L-Glutamine	584.00
	Glycine	30.00
	L-Histidine x HCl x H ₂ O	42.00
	L-Isoleucine	104.80
	L-Leucine	104.80
	L-Lysine x HCl	146.20
	L-Methionine	30.00
	L-Phenylalanine	66.00
	L-Serine	42.00
	L-Threonine	95.20
	L-Tryptophan	16.00
	L-Tyrosine x 2Na	103.79
L-Valine	93.60	
Vitamins	D-Calcium pantothenate	4.00
	Choline chloride	4.00
	Folic acid	4.00
	myo-Inositol	7.00
	Nicotinamide	4.00
	Pyridoxine x HCl	4.00
	Riboflavin	0.40
Thiamine x HCl	4.00	

If 5,958.00 mg/L HEPES are included there are only 5,400.00 mg/L sodium chloride.

- (1) usually on stock
 (2) minimum order 20 pieces
 (3) available upon request

Table for DMEM without Glucose

	L-Glutamine	Stable Glutamine	Sodium pyruvate	Phenol red	Special
P04-01548S1				x	
P04-01549			x	x	
P04-01548					
P04-01551	x		x	x	See above

Table for DMEM with 1.0 g/L Glucose

	L-Glutamine	Stable Glutamine	Sodium pyruvate	Phenol red	HEPES	Special
P04-01159			x			
P04-01500			x	x		
P04-01550	x		x	x		
P04-02500		x	x	x		
P04-01515	x		x			
P04-05551	x		x	x	25 mM	
P04-02500S1		x	x			
P04-01501			x	x		See above
P04-01504		x	x	x		See above
P04-02501		x	x	x		See above
P04-03556						See above
P04-01516	x					See above
P04-01555	x			x		See above

Table for DMEM with 4.5 g/L Glucose

	L-Glutamine	Stable Glutamine	Sodium pyruvate	Phenol red	HEPES	Special
P04-03500				x		
P04-03600			x	x		
P04-03550	x			x		
P04-03590	x		x	x		
P04-03596	x		x	x		
P04-04500		x		x		
P04-04510		x	x	x		
P04-01161						
P04-01158			x			
P04-03591	x		x			
P04-05540	x			x	25 mM	
P04-05550	x		x	x	25 mM	
P04-03588		x	x			
P04-04550		x		x	25 mM	See above
P04-05545	x				25 mM	See above
P04-01597			x	x	25 mM	See above
P04-03598	x		x	x		See above
P04-04057	x			x	25 mM	See above
P04-03560	x			x		See above
P04-01163		x	x		25 mM	See above
P04-03503				x		See above

DMEM/F12

Description

This medium supports the growth of almost all cell lines. For example, it is used for pancreas cells, Sertoli cells or to culture cells, which are used for human protein production. It combines the advantages of both media DMEM (high concentration of amino acids and vitamins) and Ham's F12 (higher concentration of zinc sulfate, putrescine and linoleic acid).

Powder Media

DMEM/F12 (1:1)⁽¹⁾
without L-Glutamine 10 L P03-6010
without NaHCO₃ 50 L P03-6050

DMEM/F12 (1:1)⁽¹⁾
with L-Glutamine 10 L P03-1110
without NaHCO₃ 50 L P03-1150

DMEM/F12 (1:1)⁽¹⁾
with L-Glutamine 10 L P03-6110
with 15 mM HEPES 50 L P03-6150
without NaHCO₃

DMEM/F12 (1:1)⁽¹⁾
with L-Glutamine 10 L P03-1210
with 25 mM HEPES 50 L P03-1250
without NaHCO₃

Composition

	Components	mg/L
Inorganic Salts	Calcium chloride x 2H ₂ O	154.45
	Iron(III)-nitrate x 9H ₂ O	0.05
	Iron(II)-sulfate x 7H ₂ O	0.42
	Potassium chloride	311.83
	Copper(II)-sulfate x 5H ₂ O	0.001
	Magnesium chloride	28.57
	Magnesium sulfate	48.85
	Sodium chloride	6,999.50
	Sodium dihydrogen phosphate	54.35
	di-Sodium hydrogen phosphate	70.98
Zinc sulfate x 7H ₂ O	0.43	
Other Components	D(+)-Glucose anhydrous	3,151.0
	Hypoxanthine	2.04
	Linoleic acid	0.04
	DL-68-Lipoic acid	0.103
	Sodium pyruvate	110.00
	Phenol red	8.10
	Putrescin x 2HCl	0.081
	Thymidine	0.36
Amino Acids	L-Alanine	4.45
	L-Arginine x HCl	147.35
	L-Asparagine x H ₂ O	7.50
	L-Aspartic acid	6.65
	L-Cystine x 2HCl	31.29
	L-Cysteine x HCl x H ₂ O	17.56
	L-Glutamine	365.00
	L-Glutamic acid	7.35
	Glycine	18.75
	L-Histidine x HCl x H ₂ O	31.48
	L-Isoleucine	54.37
	L-Leucine	58.96
	L-Lysine x HCl	91.37
	L-Methionine	17.24
	L-Phenylalanine	35.48
	L-Proline	17.27
	L-Serine	26.25
	L-Threonine	53.55
	L-Tryptophan	9.02
	L-Tyrosine x 2Na x 2H ₂ O	55.81
L-Valine	53.00	
Vitamins	D(+)-Biotin	0.004
	D-Calcium pantothenate	2.12
	Choline chloride	8.98
	Folic acid	2.66
	myo-Inositol	12.51
	Nicotinamide	2.02
	Pyridoxine x HCl	2.03
	Riboflavin	0.22
	Thiamine x HCl	2.17
	Vitamin B12	0.68

(1) usually on stock

(2) minimum order 20 pieces

(3) available upon request

DMEM/F12

Liquid Media

DMEM/F12 (1:1)⁽¹⁾
without L-Glutamine
with 1.2 g/L NaHCO₃ 500 ml P04-41450

DMEM/F12 (1:1)⁽¹⁾
with L-Glutamine
with 1.2 g/L NaHCO₃ 500 ml P04-41500

DMEM/F12 (1:1)⁽¹⁾
with stable Glutamine
with 1.2 g/L NaHCO₃ 500 ml P04-41150

DMEM/F12 (1:1)⁽¹⁾
without L-Glutamine
with 15 mM HEPES
with 1.2 g/L NaHCO₃ 500 ml P04-41550

DMEM/F12 (1:1)⁽¹⁾
with L-Glutamine
with 15 mM HEPES
with 1.2 g/L NaHCO₃ 500 ml P04-41250

DMEM/F12 (1:1)⁽¹⁾
with L-Glutamine
without Phenol red
with 1.2 g/L NaHCO₃ 500 ml P04-41650

Special Media

DMEM/F12 (1:1)⁽²⁾
without L-Glutamine
without Glucose
with 1.2 g/L NaHCO₃ 500 ml P04-41151

DMEM/F12 (1:1)⁽²⁾
with L-Glutamine
with 25 mM HEPES
with 1.2 g/L NaHCO₃ 500 ml P04-41252

DMEM/F12 (1:1)⁽²⁾
with stable Glutamine
with 15 mM HEPES
without Calcium chloride
with 1.2 g/L NaHCO₃ 500 ml P04-41251

Table for DMEM/F12

	L-Glutamine	Stable Glutamine	Phenol red	HEPES	Special
P04-41450			x		
P04-41500	x		x		
P04-41150		x	x		
P04-41550			x	15 mM	
P04-41250	x		x	15 mM	
P04-41650	x				
P04-41151			x		See above
P04-41252	x		x	25 mM	See above
P04-41251		x	x	15 mM	See above

(1) usually on stock

(2) minimum order 20 pieces

(3) available upon request

Grace`s Insect Medium

Description

The Grace`s Insect Medium was originally developed to culture insect cells including SF9 and SF21 cells. Moreover it supports a broad range of lepidopteran cells.

Special Media

Grace`s Insect Medium⁽²⁾
without L-Glutamine
with 0.35 g/L NaHCO₃ 500 ml P04-81500

Grace`s Insect Medium⁽²⁾
with L-Glutamine
with 0.35 g/L NaHCO₃ 500 ml P04-82500

Powder Media

Grace`s Insect Medium⁽¹⁾
without L-Glutamine 10 L P03-9010
without NaHCO₃ 50 L P03-9050

Grace`s Insect Medium⁽¹⁾
with L-Glutamine 10 L P03-9110
without NaHCO₃ 50 L P03-9150

Composition

	Components	mg/L
Inorganic Salts	Calcium chloride x 2H ₂ O	1,324.6
	Potassium chloride	2,240.00
	Magnesium chloride x 6H ₂ O	2,278.86
	Magnesium sulfate anhydrous	1,357.86
	di-Sodium hydrogen phosphate	876.92
Other Components	DL-Malic acid	670.00
	Succinic acid	60.00
	Fructose	400.00
	Fumaric acid	55.00
	D(+)-Glucose anhydrous	700.00
	α-Ketoglutaric acid sodium salt	425.66
Amino Acids	D-Sucrose	26,680.00
	β-Alanine	200.00
	L-Alanine	225.00
	L-Arginine x HCl	700.00
	L-Asparagine x H ₂ O	350.00
	L-Aspartic acid	350.00
	L-Cystine	19.18
	L-Glutamine	600.00
	L-Glutamic acid	600.00
	Glycine	650.00
	L-Histidine base	2,500.00
	L-Isoleucine	50.00
	L-Leucine	75.00
	L-Lysine x HCl	625.00
	L-Methionine	50.00
	L-Phenylalanine	150.00
	L-Proline	350.00
	L-Serine	550.00
	L-Threonine	175.00
	L-Tryptophan	100.00
L-Tyrosine	50.00	
L-Valine	100.00	
Vitamins	p-Aminobenzoic acid	0.02
	D(+)-Biotin	0.01
	D-Ca-Pantothenate	0.02
	Choline chloride	0.20
	Folic acid	0.02
	myo-Inositol	0.02
	Niacin	0.02
	Pyridoxine x HCl	0.02
	Riboflavin	0.02
Thiamine x HCl	0.02	

(1) usually on stock
(2) minimum order 20 pieces
(3) available upon request

Ham`s F10 Medium

Description

Ham`s F10 is an alternative to Ham`s F12 and it was used primarily to culture CHO-cells. Today, Ham`s F10 can be used with or without FBS for many different cell cultures. It is used for example for primary cells of rat and chicken, but also for human diploid cells.

Liquid Media

Ham`s F10 Medium⁽¹⁾
with L-Glutamine
with 1.2 g/L NaHCO₃ 500 ml P04-12500

Special Media

Ham`s F10 Medium⁽²⁾
without L-Glutamine
with 1.2 g/L NaHCO₃ 500 ml P04-12050

Ham`s F10 Medium⁽²⁾
with stable Glutamine
with 1.2 g/L NaHCO₃ 500 ml P04-13500

Ham`s F10 Medium⁽²⁾
with L-Glutamine
with 25 mM HEPES
with 1.2 g/L NaHCO₃ 500 ml P04-13050

Ham`s F10 Medium⁽²⁾
without L-Glutamine
without Phenol red
with 1.2 g/L NaHCO₃ 500 ml P04-12049

Powder Media

Ham`s F-10 Medium⁽¹⁾
without L-Glutamine 10 L P03-5010
without NaHCO₃ 50 L P03-5050

Ham`s F-10 Medium⁽¹⁾
with L-Glutamine 10 L P03-3910
without NaHCO₃ 50 L P03-3950

Ham`s F-10 Medium⁽¹⁾
with L-Glutamine 10 L P03-4010
with 25 mM HEPES 50 L P03-4050
without NaHCO₃

Composition

	Components	mg/L
Inorganic Salts	Calcium chloride x 2H ₂ O	44.09
	Copper(II) sulfate x 5H ₂ O	0.003
	Iron(II) sulfate x 7H ₂ O	0.834
	Magnesium sulfate anhydrous	74.60
	Potassium chloride	285.00
	Potassium dihydrogen phosphate	83.00
	Sodium chloride	7,400.00
	di-Sodium hydrogen phosphate	153.70
	Zinc sulfate x 7H ₂ O	0.029
	Other Components	D(+)-Glucose anhydrous
Hypoxanthine		4.08
DL- α -Lipoic acid		0.21
HEPES		5,958.00
Phenol red		1.20
Sodium pyruvate		110.00
2` - Deoxythymidine		0.73
Amino Acids	L-Alanine	8.91
	L-Arginine x HCl	211.00
	L-Asparagine x H ₂ O	15.00
	L-Aspartic acid	13.30
	L-Cysteine x HCl x H ₂ O	35.12
	L-Glutamine	146.20
	L-Glutamic acid	14,70
	Glycine	7.51
	L-Histidine x HCl x H ₂ O	21.00
	L-Isoleucine	2.60
	L-Leucine	13.10
	L-Lysine x HCl	29.30
	L-Methionine	4.48
	L-Phenylalanine	4.96
	L-Proline	11.50
	L-Serine	10.50
	L-Threonine	3.57
L-Tryptophan	0.60	
L-Tyrosine	1.81	
L-Valine	3.50	
Vitamins	D(+)-Biotin	0.024
	D-Calcium pantothenate	0.715
	Choline chloride	0.698
	Folic acid	1.32
	myo-Inositol	0.541
	Nicotinamide	0.615
	Pyridoxine x HCl	0.21
	Riboflavin	0.376
	Thiamine x HCl	1.01
	Vitamin B12	1.36

If 5,958.00 mg/L HEPES are included there are only 6,900.00 mg/L sodium chloride.

- (1) usually on stock
(2) minimum order 20 pieces
(3) available upon request

Ham`s F12 Medium

Description

In the past Ham`s F12 was the first choice for a serum-free cultivation of CHO-cells and is now substituted through better serum-free systems like our Panserin C6000, which is protein-free in addition. However, Ham`s F12 is an appropriate medium for mammalian cells when it is supplemented with FBS. It contains a high concentration of vitamins, amino acids and trace elements. The content of zinc sulfate is increased and it contains putrescine and linoleic acid.

Liquid Media

Ham`s F12 Medium⁽¹⁾
without L-Glutamine
with 1.176 g/L NaHCO₃ 500 ml P04-14550

Ham`s F12 Medium⁽¹⁾
with L-Glutamine
with 1.176 g/L NaHCO₃ 500 ml P04-14500

Ham`s F12 Medium⁽¹⁾
with stable Glutamine
with 1.176 g/L NaHCO₃ 500 ml P04-15500

Special Media

Ham`s F12 Medium⁽²⁾
with L-Glutamine
without Phenol red
with 25 mM HEPES
with 1.176 g/L NaHCO₃ 500 ml P04-14501

Ham`s F12 Medium⁽²⁾
without L-Glutamine
without Phenol red
with 1.176 g/L NaHCO₃ 500 ml P04-14559

Ham`s F12K Medium⁽²⁾
with L-Glutamine
with 2.5 g/L NaHCO₃ 500 ml P04-15600

Powder Media

Ham`s F12 Medium⁽¹⁾
with L-Glutamine 10 L P03-4110
without NaHCO₃ 50 L P03-4150

Composition

	Components	mg/L
Inorganic Salts	Calcium chloride anhydrous	33.30
	Copper(II) sulfate x 5H ₂ O	0.003
	Iron(II) sulfate x 7H ₂ O	0.834
	Magnesium chloride x 6H ₂ O	122.00
	Potassium chloride	223.65
	Sodium chloride	7599.9
	di-Sodium hydrogen phosphate anhydrous	142.04
	Zinc sulfate x 7H ₂ O	0.86
Other Components	D(+)-Glucose anhydrous	1,801.60
	HEPES	5,958.00
	Hypoxanthine	4.08
	Linoleic acid	0.084
	DL-Lipoic acid	0.21
	Phenol red	1.20
	Putrescine x 2HCl	0.16
	Sodium pyruvate	110.00
	Thymidine	0.73
Amino Acids	L-Alanine	8.91
	L-Arginine x HCl	210.70
	L-Asparagine x H ₂ O	15.01
	L-Aspartic acid	13.31
	L-Cysteine x HCl x H ₂ O	35.12
	L-Glutamine	146.20
	L-Glutamic acid	14.71
	Glycine	7.51
	L-Histidine x HCl x H ₂ O	20.96
	L-Isoleucine	3.94
	L-Leucine	13.12
	L-Lysine x HCl	36.54
	L-Methionine	4.48
	L-Phenylalanine	4.96
	L-Proline	34.53
	L-Serine	10.51
L-Threonine	11.91	
L-Tryptophan	2.04	
L-Tyrosine	5.44	
L-Valine	11.71	
Vitamins	D(+)-Biotin	0.007
	D-Calcium pantothenate	0.24
	Choline chloride	13.96
	Folic acid	1.32
	myo-Inositol	18.00
	Nicotinamide	0.037
	Pyridoxine x HCl	0.062
	Riboflavin	0.038
	Thiamine x HCl	0.34
	Vitamin B12	1.36

If 5,958.00 mg/L HEPES are included there are only 7,099.00 mg/L sodium chloride.

(1) usually on stock

(2) minimum order 20 pieces

(3) available upon request

Table for Ham's F10 Medium

	L-Glutamine	Stable Glutamine	Phenol red	HEPES	Special
P04-12500	x		x		
P04-12050			x		See above
P04-13500		x	x		See above
P04-13050	x		x	25 mM	See above
P04-12049					See above

Table for Ham's F12 Medium

	L-Glutamine	Stable Glutamine	Phenol red	HEPES	Special
P04-14550			x		
P04-14500	x		x		
P04-15500		x	x		
P04-14501	x			25 mM	See above
P04-14559					See above
P04-15600	x		x		See above

Iscove`s Modified Dulbecco`s Medium

Description

The IMDM is a modified DMEM, with a higher content of vitamins, selenium and amino acids. As it is supplemented with albumin, transferrin and soy lipids it can be excellently applied for culturing lymphocytes, marrow cells or hybridoma cells. Note: for hybridomas there is a better and highly efficient protein-free medium available: our Panserin H4000.

Liquid Media

IMDM⁽¹⁾
without L-Glutamine
with 3.024 g/L NaHCO₃ 500 ml P04-20250

IMDM⁽¹⁾
with L-Glutamine
with 3.024 g/L NaHCO₃ 500 ml P04-20350

IMDM⁽¹⁾
without L-Glutamine
with 25 mM HEPES
with 3.024 g/L NaHCO₃ 500 ml P04-20050

IMDM⁽¹⁾
with L-Glutamine
with 25 mM HEPES
with 3.024 g/L NaHCO₃ 500 ml P04-20150

IMDM⁽¹⁾
with stable Glutamine
with 25 mM HEPES
with 3.024 g/L NaHCO₃ 500 ml P04-20450

Composition

	Components	mg/L
Inorganic Salts	Calcium chloride anhydrous	165.00
	Potassium chloride	330.00
	Potassium nitrate	0.076
	Magnesium sulfate anhydrous	97.66
	Sodium chloride	5,005.00
	Sodium dihydrogen phosphate x H ₂ O	125.00
	Sodium selenite x 5H ₂ O	0.01
Other Components	D(+)-Glucose anhydrous	4,500.00
	HEPES	5,958.00
	Sodium pyruvate	110.00
	Phenol red	15.00
Amino Acids	L-Alanine	25.00
	L-Arginine x HCl	84.00
	L-Asparagine x H ₂ O	28.40
	L-Aspartic acid	30.00
	L-Cystine x 2HCl	91.24
	L-Glutamine	584.00
	L-Glutamic acid	75.00
	Glycine	30.00
	L-Histidine x HCl x H ₂ O	42.00
	L-Isoleucine	105.00
	L-Leucine	105.00
	L-Lysine x HCl	146.00
	L-Methionine	30.00
	L-Phenylalanine	66.00
	L-Proline	40.00
	L-Serine	42.00
L-Threonine	95.00	
L-Tryptophan	16.00	
L-Tyrosine x 2Na x 2H ₂ O	104.2	
L-Valine	94.00	
Vitamins	D(+)-Biotin	0.0130
	D-Calcium pantothenate	4.00
	Choline chloride	4.00
	Folic acid	4.00
	myo-Inositol	7.20
	Nicotinamide	4.00
	Pyridoxine x HCl	4.00
	Riboflavin	0.40
	Thiamine x HCl	4.00
	Vitamin B12	0.013

If 5,958.00 mg/L HEPES are included there are only 4,505.00 mg/L sodium chloride.

- (1) usually on stock
(2) minimum order 20 pieces
(3) available upon request

Iscove`s Modified Dulbecco`s Medium

Special Media

IMDM ⁽²⁾ without L-Glutamine with 1.0 g/L Glucose with 3.024 g/L NaHCO ₃	500 ml	P04-20259
IMDM ⁽²⁾ with stable Glutamine with 25 mM HEPES without Phenol red		
315 mOsm* with 3.024 g/L NaHCO ₃	500 ml	P04-20451S1
IMDM ⁽²⁾ with L-Glutamine with 25 mM HEPES		
320 mOsm* with 3.024 g/L NaHCO ₃	500 ml	P04-20150S2
IMDM ⁽²⁾ with L-Glutamine with 1.5 g/L NaHCO ₃	500 ml	P04-20351
IMDM ⁽²⁾ with stable Glutamine with 25 mM HEPES without Phenol red with 3.024 g/L NaHCO ₃	500 ml	P04-20451

* Due to osmolality, the salt concentration can vary.

Powder Media

IMDM ⁽¹⁾ without L-Glutamine	10 L	P03-5210
without NaHCO ₃	50 L	P03-5250
IMDM ⁽¹⁾ with L-Glutamine	10 L	P03-1310
without NaHCO ₃	50 L	P03-1350
IMDM ⁽¹⁾ with L-Glutamine with 25 mM HEPES	10 L	P03-1410
without NaHCO ₃	50 L	P03-1450

- (1) usually on stock
- (2) minimum order 20 pieces
- (3) available upon request

Table for Iscove`s Modified Dulbecco`s Medium

	L-Glutamine	Stable Glutamine	Phenol red	HEPES	Special
P04-20250			x		
P04-20350	x		x		
P04-20050			x	25 mM	
P04-20150	x		x	25 mM	
P04-20450		x	x	25 mM	
P04-20259			x		See above
P04-20451S1		x		25 mM	See above
P04-20150S2	x		x	25 mM	See above
P04-20351	x		x		See above
P04-20451		x		25 mM	See above

IPL-41 Insect Medium

Composition

	Components	mg/L
Inorganic Salts	Ammonium molybdate x 4H ₂ O	0.04
	Calcium chloride x 2H ₂ O	662.31
	Cobalt(II) chloride x 6H ₂ O	0.05
	Copper(I) chloride	0.20
	Iron(II) sulfate x 7H ₂ O	0.55
	Magnesium sulfate dried	1,311.40
	Manganese chloride x 4H ₂ O	0.02
	Potassium chloride	1,200.00
	Sodium chloride	2,850.00
	Sodium dihydrogen phosphate x H ₂ O	1,160.00
	Zinc chloride	0.04
	Other Components	Fumaric acid
D(+)-Glucose anhydrous		2,500.00
α-Ketoglutaric acid sodium salt		34.05
DL-Malic acid		53.60
D-Maltose x H ₂ O		1,052.58
Succinic acid		4.80
Sucrose		1,650.00
Amino Acids	β-Alanine	300.00
	L-Arginine x HCl	800.00
	L-Aspartic acid	1,300.00
	L-Asparagine x H ₂ O	1,477.14
	L-Cystine	100.00
	L-Glutamine	1,000.00
	L-Glutamic acid	1,500.00
	Glycine	200.00
	L-Histidine base	200.00
	L-Hydroxyproline	800.00
	L-Isoleucine	750.00
	L-Leucine	250.00
	L-Lysine x HCl	700.00
	L-Methionine	1,000.00
	L-Phenylalanine	1,000.00
	L-Proline	500.00
	L-Serine	200.00
	L-Threonine	200.00
L-Tryptophan	100.00	
L-Tyrosine	250.02	
L-Valine	500.00	
Vitamins	p-Aminobenzoic acid	0.32
	D(+)-Biotin	0.16
	D-Calcium pantothenate	0.008
	Choline chloride	20.00
	Folic acid	0.08
	myo-Inositol	0.40
	Nicotinic acid	0.16
	Nicotinamide	0.16
	Pyridoxine x HCl	0.40
	Riboflavin	0.08
	Thiamine x HCl	0.08
Vitamin B12	0.24	

Description

IPL-41 is primarily used for the growth and maintenance of lepidopteran cells and for the propagation of viruses in these cells lines. The medium is also used for long time culture of baculo-virus infected spodoptera cells.

Special Media

IPL-41 Insect Medium⁽²⁾
with L-Glutamine
with 0.35 g/L NaHCO₃ 500 ml P04-85600

Powder Media

IPL-41 Insect Medium⁽¹⁾
without L-Glutamine 10 L P03-9210
without NaHCO₃ 50 L P03-9250

- (1) usually on stock
(2) minimum order 20 pieces
(3) available upon request

Joklik-MEM

Description

Joklik's MEM is a modification of MEM for suspension cultures. Due to the absence of calcium chloride in this formulation the attachment of cells is reduced.

Composition

	Components	mg/L
Inorganic Salts	Magnesium chloride x 6H ₂ O	200.00
	Potassium chloride	400.00
	Sodium chloride	6,500.00
	Sodium dihydrogen phosphate x H ₂ O	1,327.00
Other Components	D(+)-Glucose anhydrous	2,000.00
	Phenol red	10.00
Amino Acids	L-Arginine x HCl	126.00
	L-Cystine	24.00
	L-Glutamine	294.00
	L-Histidine base	31.00
	L-Isoleucine	52.00
	L-Leucine	52.00
	L-Lysine x H ₂ O	65.00
	L-Methionine	15.00
	L-Phenylalanine	32.00
	L-Threonine	48.00
	L-Tryptophan	10.00
	L-Tyrosine	32.60
L-Valine	46.00	
Vitamins	D-Calcium pantothenate	1.00
	Choline chloride	1.00
	Folic acid	1.00
	myo-Inositol	2.00
	Nicotinamide	1.00
	Pyridoxal x HCl	1.00
	Riboflavin	0.10
	Thiamine x HCl	1.00

Liquid Media

Joklik - MEM⁽¹⁾
 HEPES Medium
 with L-Glutamine
 with 3.6 g/L HEPES 500 ml P04-21300

Special Media

Joklik - MEM⁽²⁾
 modified for spinner culture
 with EBSS (modified)
 without L-Glutamine
 without Antibiotics
 without Calcium chloride
 with 2.0 g/L NaHCO₃ 500 ml P04-21200

Powder Media

Joklik - MEM⁽¹⁾
 modified for spinner culture
 with EBSS (modified)
 without L-Glutamine
 without Antibiotics
 without Calcium chloride 10 L P03-02010P
 without NaHCO₃ 50 L P03-02050P

(1) usually on stock
 (2) minimum order 20 pieces
 (3) available upon request

Leibovitz's L-15 Medium

Description

L-15 contains no sodium hydrogen carbonate because it is buffered already by a high concentration of amino acids. The L-15 medium supports the growth of established cells like Hep-2, but also human nerve cells and primary tissue explants. With 10 % tryptose phosphate broth it is also ideally suited for the cultivation of insect cell lines.

Composition

	Components	mg/L
Inorganic Salts	Calcium chloride x 2H ₂ O	185.44
	Magnesium chloride x 6H ₂ O	200.00
	Magnesium sulfate anhydrous	97.67
	Potassium chloride	400.00
	Potassium dihydrogen phosphate	60.00
	Sodium chloride	8,000.00
	di-Sodium hydrogen phosphate	190.00
Other Components	D(+)-Galactose anhydrous	900.00
	HEPES	5,958.00
	Phenol red	10.00
	Sodium pyruvate	550.00
Amino Acids	L-Alanine	225.00
	L-Arginine base	500.00
	L-Asparagine x H ₂ O	250.00
	L-Cysteine	120.00
	L-Glutamine	300.00
	Glycine	200.00
	L-Histidine base	250.00
	L-Isoleucine	250.00
	L-Leucine	125.00
	L-Lysine x HCl	93.75
	L-Methionine	75.00
	L-Phenylalanine	125.00
	L-Serine	200.00
	L-Threonine	300.00
	L-Tryptophan	20.00
	L-Tyrosine	300.00
L-Valine	100.00	
Vitamins	D-Calcium pantothenate	1.00
	Choline chloride	1.00
	Folic acid	1.00
	myo-Inositol	2.00
	Nicotinamide	1.00
	Pyridoxine x HCl	1.00
	Riboflavin-5'-phosphate sodium salt x 2H ₂ O	0.1075
	Thiamine monophosphate chloride x 2H ₂ O	1.00

If 5,958.00 mg/L HEPES are included there are only 7,500.00 mg/L sodium chloride.

Liquid Media

Leibovitz's L-15 Medium⁽¹⁾
without L-Glutamine
without NaHCO₃ 500 ml P04-27055

Leibovitz's L-15 Medium⁽¹⁾
with L-Glutamine
without NaHCO₃ 500 ml P04-27500

Special Media

Leibovitz's L-15 Medium⁽²⁾
with stable Glutamine
without NaHCO₃ 500 ml P04-27050

Leibovitz's L-15 Medium⁽²⁾
without L-Glutamine
without Phenol red
without NaHCO₃ 500 ml P04-27054

Powder Media

Leibovitz's L-15 Medium⁽¹⁾
with L-Glutamine 10 L P03-1510
without NaHCO₃ 50 L P03-1550

Leibovitz's L-15 Medium⁽¹⁾
with L-Glutamine
with 25 mM HEPES 10 L P03-1610
without NaHCO₃ 50 L P03-1650

- (1) usually on stock
(2) minimum order 20 pieces
(3) available upon request

Table for Leibovitz` s L-15 Medium

	L-Glutamine	Stable Glutamine	Phenol red	Special
P04-27055			x	
P04-27500	x		x	
P04-27050		x	x	See above
P04-27054				See above

McCoy's 5A Medium

Description

McCoy's 5A Medium is a complete medium with all amino acids and vitamins. It is used for growing primary cultures. This group contains marrow cells, gingival cells, adrenal cells, spleen cells, lung cells, rat embryos and other cell types.

Liquid Media

McCoy's 5A Medium (modified)⁽¹⁾
with L-Glutamine
with 2.2 g/L NaHCO₃ 500 ml P04-05500

McCoy's 5A Medium (modified)⁽¹⁾
with stable Glutamine
with 2.2 g/L NaHCO₃ 500 ml P04-06500

Special Media

McCoy's 5A Medium (modified)⁽²⁾
with L-Glutamine
with 25 mM HEPES
with 2.2 g/L NaHCO₃ 500 ml P04-05050

McCoy's 5A Medium⁽²⁾
without L-Glutamine
without Phenol red
with 2.2 g/L NaHCO₃ 500 ml P04-05610

Powder Media

McCoy's 5A Medium (modified)⁽¹⁾
with L-Glutamine 10 L P03-1710
without NaHCO₃ 50 L P03-1750

McCoy's 5A Medium (modified)⁽¹⁾
with L-Glutamine 10 L P03-1810
with 25 mM HEPES 10 L P03-1810
without NaHCO₃ 50 L P03-1850

Composition

	Components	mg/L
Inorganic Salts	Calcium chloride x 2H ₂ O	132.46
	Magnesium sulfate anhydrous	97.67
	Potassium chloride	400.00
	Sodium chloride	6,460.00
	Sodium dihydrogen phosphate x H ₂ O	580.00
Other Components	D(+)-Glucose anhydrous	3,000.00
	Glutathione (red.)	0.50
	HEPES	5,958.00
	Bacto - Peptone	600.00
	Phenol red	10.00
Amino Acids	L-Alanine	13.36
	L-Arginine x HCl	42.10
	L-Asparagine x H ₂ O	45.00
	L-Aspartic acid	19.97
	L-Cysteine	24.24
	L-Glutamine	219.20
	L-Glutamic acid	22.10
	Glycine	7.50
	L-Histidine x HCl x H ₂ O	20.76
	L-Hydroxyproline	19.70
	L-Isoleucine	39.36
	L-Leucine	39.36
	L-Lysine x HCl	36.50
	L-Methionine	14.90
	L-Phenylalanine	16.50
	L-Proline	17.30
	L-Serine	26.30
	L-Threonine	17.90
L-Tryptophan	3.10	
L-Tyrosine	18.10	
L-Valine	17.60	
Vitamins	p-Aminobenzoic acid	1.00
	Ascorbic acid	0.50
	D(+)-Biotin	0.20
	D-Calcium pantothenate	0.20
	Choline chloride	5.00
	Folic acid	10.00
	myo-Inositol	36.00
	Nicotinamide	0.50
	Nicotinic acid	0.50
	Pyridoxal x HCl	0.50
	Pyridoxine x HCl	0.50
	Riboflavin	0.20
	Thiamine x HCl	0.20
	Vitamin B12	2.00

If 5,958.00 mg/L HEPES are included there are only 5,960.00 mg/L sodium chloride.

- (1) usually on stock
(2) minimum order 20 pieces
(3) available upon request

Table for McCoy's 5A Medium

	L-Glutamine	Stable Glutamine	Phenol red	HEPES	Special
P04-05500	x		x		
P04-06500		x	x		
P04-05050	x		x	25 mM	See above
P04-05610					See above

MCDB 131 Medium

Composition

	Components	mg/L
Inorganic Salts	Ammonium metavanadate	0.0006
	Calcium chloride x 2H ₂ O	235.05
	Copper(II) sulfate x 5H ₂ O	0.0012
	Iron (III) sulfate x 7H ₂ O	0.283
	Magnesium sulfate anhydrous	1,204.00
	Manganese chloride x 4H ₂ O	0.0002
	Ammonium molybdate x 4H ₂ O	0.0037
	Nickel chloride x 6H ₂ O	0.0007
	Potassium chloride	298.00
	Sodium chloride	6,430.00
	Sodium metasilicate	2.09
	di-Sodium hydrogen phosphate	71.00
	Sodium selenite anhydrous	0.0052
	Zinc sulfate x 7H ₂ O	0.0003
Other Components	Adenine	0.135
	D-Glucose	1,000.00
	DL- α -Lipoic acid	0.0021
	HEPES	5,958.00
	Phenol red	10.00
	Putrescine x 2HCl	0.002
	Sodium pyruvate	110.00
	2'-Deoxythymidine	0.024
Amino Acids	L-Alanine	2.70
	L-Arginine x HCl	63.20
	L-Asparagine x H ₂ O	15.00
	L-Aspartic acid	13.30
	L-Cysteine x HCl x H ₂ O	35.00
	L-Glutamic acid	4.00
	L-Glutamine	1,461.00
	Glycine	2.30
	L-Histidine x HCl x H ₂ O	42.00
	L-Isoleucine	66.00
	L-Leucine	131.00
	L-Lysine x HCl	182.00
	L-Methionine	15.00
	L-Phenylalanine	33.00
	L-Proline	11.50
	L-Serine	32.00
	L-Threonine	12.00
	L-Tryptophan	4.10
L-Tyrosine	18.10	
L-Valine	117.10	
Vitamins	Choline Chloride	13.96
	D(+)-Biotin	0.0073
	Folic Acid	0.60
	myo-Inositol	7.20
	Niacinamide	6.10
	D-Calcium pantothenate	12.00
	Pyridoxine x HCl	2.10
	Riboflavin	0.0038
	Thiamine x HCl	3.40
	Vitamin B12	0.0136

If 5,958.00 mg/L HEPES are included there are only 4,400.00 mg/L sodium chloride.

Description

MCDB 131 is a medium for the cultivation of human micro-vascular endothelial cells under reduced serum content. For this purpose it has be supplemented with dialyzed serum, EGF and hydrocortisone.

Liquid Media

MCDB 131⁽¹⁾
without L-Glutamine
with 1.176 g/L NaHCO₃ 500 ml P04-80057

Special Media

MCDB 131⁽²⁾
with L-Glutamine
with 1.176 g/L NaHCO₃ 500 ml P04-80053

MCDB 131⁽²⁾
without Glutamine
with 25 mM HEPES
with 1.176 g/L NaHCO₃ 500 ml P04-80054

- (1) usually on stock
- (2) minimum order 20 pieces
- (3) available upon request

Medium 199 with Earle's Salts

Description

The M199 was originally developed to assay the nutrient demand of embryonic chicken fibroblasts. But it works very well with cells from many different animal species. For example, it is used for vaccine production in virology. For long term cultures serum should be added.

Composition

	Components	mg/L
Inorganic Salts	Calcium chloride x 2H ₂ O	264.92
	Iron(III) nitrate x 9H ₂ O	0.72
	Magnesium sulfate anhydrous	97.67
	Potassium chloride	400.00
	Sodium acetate x 3H ₂ O	82.95
	Sodium chloride	6,800.00
	Sodium dihydrogen phosphate	140.00
	Other Components	Adenine sulfate
AMP		0.20
ATP		1.00
Cholesterol		0.20
2'-Deoxyribose		0.50
D(+)-Glucose anhydrous		1,000.00
Glutathione (red.)		0.05
Guanine x HCl		0.30
HEPES		5,958.00
Hypoxanthine		0.30
Phenol red		10.00
D-Ribose		0.50
Thymine		0.30
Tween 80		4.90
Uracil		0.30
Xanthine		0.30
Amino Acids		L-Alanine
	L-Arginine x HCl	70.00
	L-Aspartic acid	30.00
	L-Cysteine x HCl x H ₂ O	0.10
	L-Cystine	20.00
	L-Glutamine	100.00
	L-Glutamic acid	67.00
	Glycine	50.00
	L-Histidine x HCl x H ₂ O	21.88
	L-Hydroxyproline	10.00
	L-Isoleucine	20.00
	L-Leucine	60.00
	L-Lysine x HCl	70.00
	L-Methionine	15.00
	L-Phenylalanine	25.00
	L-Proline	40.00
	L-Serine	25.00
	L-Threonine	30.00
	L-Tryptophan	10.00
	L-Tyrosine	40.00
L-Valine	25.00	

Vitamins		
	p-Aminobenzoic acid	0.05
	Ascorbic acid	0.05
	D(+)-Biotin	0.01
	Calciferol	0.10
	D-Calcium pantothenate	0.01
	Choline chloride	0.50
	Folic acid	0.01
	myo-Inositol	0.05
	Menadione	0.01
	Nicotinic acid	0.025
	Nicotinamide	0.025
	Pyridoxal x HCl	0.025
	Pyridoxol x HCl	0.025
	Riboflavin	0.01
	DL- α -Tocopherol phosphate-disodium salt	0.01
	Thiamine x HCl	0.01
	Vitamin A acetate	0.14

If 5,958.00 mg/L HEPES are included there are only 6,300.00 mg/L sodium chloride.

Liquid Media

M199 with EBSS⁽¹⁾
without L-Glutamine
with 2.2 g/L NaHCO₃ 500 ml P04-07500

M199 with EBSS⁽¹⁾
with L-Glutamine
with 2.2 g/L NaHCO₃ 500 ml P04-07050

Special Media

M199 with EBSS⁽²⁾
with stable Glutamine
with 2.2 g/L NaHCO₃ 500 ml P04-07250

M199 with EBSS⁽²⁾
with L-Glutamine
with 25 mM HEPES
with 2.2 g/L NaHCO₃ 500 ml P04-07150

Powder Media

M199 with EBSS⁽¹⁾
with L-Glutamine 10 L P03-1910
without NaHCO₃ 50 L P03-1950

(1) usually on stock

(2) minimum order 20 pieces

(3) available upon request

Medium 199 with Hank's Salts

Special Media

M199 with HBSS⁽²⁾
without L-Glutamine
with 0.35 g/L NaHCO₃ 500 ml P04-07753

M199 with HBSS⁽²⁾
with L-Glutamine
with 25 mM HEPES
with 0.35 g/L NaHCO₃ 500 ml P04-07450

M199 with HBSS (10X)⁽²⁾
without L-Glutamine
without NaHCO₃ 500 ml P04-07600

Powder Media

M199 with HBSS⁽¹⁾
with L-Glutamine 10 L P03-2110
without NaHCO₃ 50 L P03-2150

Composition

	Components	mg/L
Inorganic Salts	Calcium chloride x 2H ₂ O	185.45
	Iron(III) nitrate x 9H ₂ O	0.72
	Magnesium sulfate anhydrous	97.67
	Potassium chloride	400.00
	Potassium dihydrogen phosphate	60.00
	Sodium acetate	50.03
	Sodium chloride	8,000.00
	di-Sodium hydrogen phosphate	47.68
Other Components	Adenine sulfate	10.00
	AMP	0.20
	ATP	1.00
	Cholesterol	0.20
	2'-Deoxyribose	0.50
	D(+)-Glucose anhydrous	1,000.00
	Glutathione (red.)	0.05
	Guanine x HCl	0.30
	HEPES	5,958.00
	Hypoxanthine	0.30
	Phenol red	10.00
	D-Ribose	0.50
	Thymine	0.30
	Tween 80	4.90
	Uracil	0.30
Xanthine	0.30	

Amino Acids	L-Alanine	25.00
	L-Arginine x HCl	70.00
	L-Aspartic acid	30.00
	L-Cysteine x HCl x H ₂ O	0.10
	L-Cystine	20.00
	L-Glutamine	100.00
	L-Glutamic acid	67.00
	Glycine	50.00
	L-Histidine x HCl x H ₂ O	21.88
	L-Hydroxyproline	10.00
	L-Isoleucine	20.00
	L-Leucine	60.00
	L-Lysine x HCl	70.00
	L-Methionine	15.00
	L-Phenylalanine	25.00
	L-Proline	40.00
	L-Serine	25.00
	L-Threonine	30.00
	L-Tryptophan	10.00
L-Tyrosine	40.00	
L-Valine	25.00	
Vitamins	p-Aminobenzoic acid	0.05
	Ascorbic acid	0.05
	D(+)-Biotin	0.01
	Calciferol	0.10
	D-Calcium pantothenate	0.01
	Choline chloride	0.50
	Folic acid	0.01
	myo-Inositol	0.05
	Menadione	0.01
	Nicotinic acid	0.025
	Nicotinamide	0.025
	Pyridoxal x HCl	0.025
Pyridoxol x HCl	0.025	
Riboflavin	0.01	
DL- α -Tocopherol phosphate-disodium salt	0.01	
Thiamine x HCl	0.01	
Vitamin A acetate	0.14	

If 5,958.00 mg/L HEPES are included there are only 7,500.00 mg/L sodium chloride.

- (1) usually on stock
(2) minimum order 20 pieces
(3) available upon request

MEM with Earle's Salts

Description

MEM is an advancement of the BME and the base medium of many further modifications. Because BME did not fulfil all requirements for some mammalian and HeLa cells, a better variation had to be developed. Today, MEM is one of the most used synthetic media and shows its versatility by supplementing with amino acids including Hank's or Earle's salts. Even the addition of only small amounts of FBS results in a positive effect on cell growth.

Composition

	Components	mg/L
Inorganic Salts	Calcium chloride x 2H ₂ O	264.92
	Magnesium sulfate anhydrous	97.67
	Potassium chloride	400.00
	Sodium chloride	6,800.00
	Sodium dihydrogen phosphate x H ₂ O	140.00
Other Components	D(+)-Glucose anhydrous	1,000.00
	HEPES	5,958.00
	Phenol red	10.00
Amino Acids	L-Arginine x HCl	126.00
	L-Cystine	24.00
	L-Histidine x HCl x H ₂ O	42.00
	L-Isoleucine	52.00
	L-Leucine	52.00
	L-Lysine x HCl	72.50
	L-Methionine	15.00
	L-Phenylalanine	32.00
	L-Threonine	48.00
	L-Tryptophan	10.00
	L-Tyrosine	36.00
L-Valine	46.00	
Vitamins	D-Calcium pantothenate	1.00
	Choline chloride	1.00
	Folic acid	1.00
	myo-Inositol	2.00
	Nicotinamide	1.00
	Pyridoxal x HCl	1.00
	Riboflavin	0.10
	Thiamine x HCl	1.00

If 5,958.00 mg/L HEPES are included there are only 6,300.00 mg/L sodium chloride.

Liquid Media without Glutamine

MEM Eagle with EBSS⁽¹⁾
without L-Glutamine
with 2.2 g/L NaHCO₃ 500 ml P04-08050

MEM Eagle with EBSS⁽¹⁾
without L-Glutamine
with 25 mM HEPES
with 2.2 g/L NaHCO₃ 500 ml P04-08150

MEM Eagle with EBSS⁽¹⁾
without L-Glutamine
with NEAA*
with 2.2 g/L NaHCO₃ 500 ml P04-08509

	Components	mg/L
Amino Acids*	L-Alanine	8.90
	L-Asparagine x H ₂ O	13.20
	L-Aspartic acid	13.30
	L-Glutamic acid	14.70
	L-Glycine	7.50
	L-Proline	11.50
	L-Serine	10.50

Special Media without Glutamine

MEM Eagle with EBSS⁽²⁾
without L-Glutamine
without Phenol red
with 2.2 g/L NaHCO₃ 500 ml P04-00507

MEM Eagle with EBSS⁽²⁾
without L-Glutamine
without NaHCO₃ 500 ml P04-09050

Powder Media without Glutamine

MEM Eagle with EBSS⁽¹⁾
without L-Glutamine 10 L P03-7410
without NaHCO₃ 50 L P03-7450

Table for MEM EBSS without Glutamine

	L-Glutamine	Stable Glutamine	NEAA	Phenol red	HEPES	Special
P04-08050				x		
P04-08150				x	25 mM	
P04-08509			x	x		
P04-00507						See above
P04-09050				x		See above

(1) usually on stock

(2) minimum order 20 pieces

(3) available upon request

MEM with Earle`s Salts

Liquid Media with L-Glutamine

MEM Eagle with EBSS⁽¹⁾
with L-Glutamine
with 2.2 g/L NaHCO₃ 500 ml P04-08500

MEM Eagle with EBSS⁽¹⁾
with L-Glutamine
with 1.5 g/L NaHCO₃ 500 ml P04-00509

MEM Eagle with EBSS⁽¹⁾
with 2 mM L-Glutamine
with 1 mM Pyruvate
with NEAA* (see page 79)
with 1.5 g/L NaHCO₃ 500 ml P04-08056

Special Media with L-Glutamine

MEM Eagle with EBSS⁽²⁾
with L-Glutamine
without Phenol red
with 1.5 g/L NaHCO₃ 500 ml P04-00508

MEM Eagle with EBSS⁽²⁾
with L-Glutamine
with 20 mM HEPES
with 2.2 g/L NaHCO₃ 500 ml P04-08549

MEM Eagle with EBSS⁽²⁾
with L-Glutamine
with NEAA* (see page 79)
with 2.2 g/L NaHCO₃ 500 ml P04-08510

Powder Media with L-Glutamine

MEM Eagle with EBSS⁽¹⁾
with L-Glutamine
with NEAA 10 L P03-2910
without NaHCO₃ 50 L P03-2950

MEM Eagle with EBSS⁽¹⁾
with L-Glutamine
with NEAA
with 25 mM HEPES 10 L P03-3010
without NaHCO₃ 50 L P03-3050

MEM Eagle with EBSS⁽¹⁾
with L-Glutamine 10 L P03-2710
without NaHCO₃ 50 L P03-2750

MEM Eagle with EBSS⁽¹⁾
with L-Glutamine
with 25 mM HEPES 10 L P03-2810
without NaHCO₃ 50 L P03-2850

Liquid Media with stable Glutamine

MEM Eagle with EBSS⁽¹⁾
with stable Glutamine
with 2.2 g/L NaHCO₃ 500 ml P04-09500

MEM Eagle with EBSS⁽¹⁾
with stable Glutamine
with 25 mM HEPES
with 2.2 g/L NaHCO₃ 500 ml P04-08250

Table for MEM EBSS with L-Glutamine

	L-Glutamine	Stable Glutamine	NEAA	Phenol red	HEPES	Special
P04-08500	x			x		
P04-00509	x			x		
P04-08056	x		x	x		
P04-00508	x					See above
P04-08549	x			x	20 mM	See above
P04-08510	x		x	x		See above

Table for MEM EBSS with stable Glutamine

	L-Glutamine	Stable Glutamine	NEAA	Phenol red	HEPES	Special
P04-09500		x		x		
P04-08250		x		x	25 mM	

- (1) usually on stock
(2) minimum order 20 pieces
(3) available upon request

MEM with Hank's Salts

Composition

	Components	mg/L
Inorganic Salts	Calcium chloride x 2H ₂ O	185.44
	Potassium chloride	400.00
	Potassium dihydrogen phosphate anhydrous	60.00
	Magnesium sulfate anhydrous	97.67
	Sodium chloride	8,000.00
	di-Sodium hydrogen phosphate	47.88
Other Components	D(+)-Glucose anhydrous	1,000.00
	HEPES	5,958.00
	Phenol red	10.00
Amino Acids	L-Arginine x HCl	126.00
	L-Cystine	24.00
	L-Glutamine	292.00
	L-Histidine x HCl x H ₂ O	42.00
	L-Isoleucine	52.00
	L-Leucine	52.00
	L-Lysine x HCl	72.50
	L-Methionine	15.00
	L-Phenylalanine	32.00
	L-Threonine	48.00
	L-Tryptophan	10.00
	L-Tyrosine	36.00
	L-Valine	46.00
Vitamins	D-Calcium pantothenate	1.00
	Choline chloride	1.00
	Folic acid	1.00
	myo-Inositol	2.00
	Nicotinamide	1.00
	Pyridoxal x HCl	1.00
	Riboflavin	0.10
	Thiamine x HCl	1.00

If 5,958.00 mg/L HEPES are included there are only 7,500.00 mg/L sodium chloride.

Liquid Media with L-Glutamine

MEM Eagle with HBSS⁽¹⁾
with L-Glutamine
with 0.35 g/L NaHCO₃ 500 ml P04-10500

Special Media

MEM Eagle with HBSS⁽²⁾
without L-Glutamine
with 0.35 g/L NaHCO₃ 500 ml P04-10050

MEM Eagle with HBSS⁽²⁾
with L-Glutamine
with 0.60 g/L NaHCO₃ 500 ml P04-10599

Powder Media

MEM Eagle with HBSS⁽¹⁾
with L-Glutamine 10 L P03-3310
without NaHCO₃ 50 L P03-3350

(1) usually on stock

(2) minimum order 20 pieces

(3) available upon request

RPMI 1640

Description

The medium was developed for culture of normal and neoplastic leukocytes, but also marrow cells and hybridoma cells. Meanwhile there are better, serum-free media for hybridoma cells such our Panser H4000. Just by supplementing RPMI 1640 with varying amounts of FBS, a very good medium for many different cell lines can be obtained.

Composition

	Components	mg/L
Inorganic Salts	Calcium nitrate x 4H ₂ O	100.00
	Potassium chloride	400.00
	Magnesium sulfate anhydrous	48.83
	Sodium chloride	6,000.00
	di-Sodium hydrogen phosphate	800.49
Other Components	D(+)-Glucose anhydrous	2,000.00
	Glutathione (red.)	1.00
	HEPES	5,958.00
	Phenol red	5.00
Amino Acids	L-Arginine x HCl	241.86
	L-Asparagine x H ₂ O	50.00
	L-Aspartic acid	20.00
	L-Cystine x 2HCl	65.19
	L-Glutamine	300.00
	L-Glutamic acid	20.00
	Glycine	10.00
	L-Histidine x HCl x H ₂ O	20.27
	L-Hydroxyproline	20.00
	L-Isoleucine	50.00
	L-Leucine	50.00
	L-Lysine x HCl	40.00
	L-Methionine	15.00
	L-Phenylalanine	15.00
	L-Proline	20.00
	L-Serine	30.00
	L-Threonine	20.00
	L-Tryptophan	5.00
L-Tyrosine x 2Na	28.83	
L-Valine	20.00	
Vitamins	p-Aminobenzoic acid	1.00
	D(+)-Biotin	0.20
	D-Calcium pantothenate	0.25
	Choline chloride	3.00
	Folic acid	1.00
	myo-Inositol	35.00
	Nicotinamide	1.00
	Pyridoxine x HCl	1.00
	Riboflavin	0.20
	Thiamine x HCl	1.00
	Vitamin B12	0.005

If 5,958.00 mg/L HEPES are included there are only 5,000.00 mg/L sodium chloride.

Liquid Media without Glutamine

RPMI 1640⁽¹⁾
without L-Glutamine
with 2.0 g/L NaHCO₃ 500 ml P04-17500

RPMI 1640⁽¹⁾
without L-Glutamine
without Phenol red
with 2.0 g/L NaHCO₃ 500 ml P04-16516

RPMI 1640⁽¹⁾
without L-Glutamine
with 25 mM HEPES
with 2.0 g/L NaHCO₃ 500 ml P04-18000

Special Media without Glutamine

RPMI 1640⁽²⁾
without L-Glutamine
without Calcium
with 2.0 g/L NaHCO₃ 500 ml P04-16151

RPMI 1640⁽²⁾
without L-Glutamine
without L-Tryptophan
with 2.0 g/L NaHCO₃ 500 ml P04-17599

RPMI 1640⁽²⁾
without L-Glutamine
without Glucose
with 2.0 g/L NaHCO₃ 500 ml P04-17550

RPMI 1640⁽²⁾
without L-Glutamine
with 15 mM HEPES
without Phosphate
with 2.0 g/L NaHCO₃ 500 ml P04-21049

RPMI 1640 (10X)⁽²⁾
without L-Glutamine
without NaHCO₃ 500 ml P04-17510

RPMI 1640⁽²⁾
without L-Glutamine
with 25 mM HEPES
without NaHCO₃ 500 ml P04-17850

RPMI 1640⁽²⁾
without L-Glutamine
with 25 mM HEPES
with 2.2 g/L NaHCO₃ 500 ml P04-22500

RPMI 1640⁽²⁾
without L-Glutamine
with 20 mM HEPES
with 0.85 g/L NaHCO₃ 500 ml P04-19500

- (1) usually on stock
(2) minimum order 20 pieces
(3) available upon request

RPMI 1640

Table for RPMI 1640 without Glutamine

	L-Glutamine	Stable Glutamine	Sodium pyruvate	Phenol red	HEPES	Special
P04-17500				x		
P04-16516						
P04-18000				x	25 mM	
P04-16151				x		See above
P04-17599				x		See above
P04-17550				x		See above
P04-21049				x	15 mM	See above
P04-17510				x		See above
P04-17850				x	25 mM	See above
P04-22500				x	25 mM	See above
P04-19500				x	20 mM	See above

Powder Media without Glutamine

RPMI 1640⁽¹⁾
 without L-Glutamine 10 L P03-7210
 without NaHCO₃ 50 L P03-7250

RPMI 1640⁽¹⁾
 without L-Glutamine
 without Phenol red 10 L P03-7710
 without NaHCO₃ 50 L P03-7750

RPMI 1640⁽¹⁾
 without L-Glutamine
 with 25 mM HEPES 10 L P03-4410
 without NaHCO₃ 50 L P03-4450

Liquid Media with L-Glutamine

RPMI 1640⁽¹⁾
 with L-Glutamine
 with 2.0 g/L NaHCO₃ 500 ml P04-16500

RPMI 1640⁽¹⁾
 with L-Glutamine
 without Phenol red
 with 2.0 g/L NaHCO₃ 500 ml P04-16515

RPMI 1640⁽¹⁾
 with 2 mM L-Glutamine
 with 1 mM Sodium pyruvate
 with 4.5 g/L Glucose
 with 10 mM HEPES
 with 1.5 g/L NaHCO₃ 500 ml P04-18047

RPMI 1640⁽¹⁾
 with L-Glutamine
 with 25 mM HEPES
 with 2.2 g/L NaHCO₃ 500 ml P04-22100

RPMI 1640⁽¹⁾
 with L-Glutamine
 without L-Tryptophan
 with 2.0 g/L NaHCO₃ 500 ml P04-17598

Special Media with L-Glutamine

RPMI 1640⁽²⁾
 with L-Glutamine
 without Glucose
 with 2.0 g/L NaHCO₃ 500 ml P04-17545

RPMI 1640⁽²⁾
 with L-Glutamine
 without L-Arginine
 with 2.0 g/L NaHCO₃ 500 ml P04-16598

RPMI 1640⁽²⁾
 with L-Glutamine
 with 20 mM HEPES
 with 0.85 g/L NaHCO₃ 500 ml P04-19550

Powder Media with L-Glutamine

RPMI 1640⁽¹⁾
 with L-Glutamine 10 L P03-4310
 without NaHCO₃ 50 L P03-4350

RPMI 1640⁽¹⁾
 with L-Glutamine
 with 25 mM HEPES 10 L P03-7310
 without NaHCO₃ 50 L P03-7350

RPMI 1640⁽¹⁾
 with L-Glutamine
 without Phenol red 10 L P03-7610
 without NaHCO₃ 50 L P03-7650

(1) usually on stock

(2) minimum order 20 pieces

(3) available upon request

RPMI 1640

Table for RPMI 1640 with L-Glutamine

	L-Glutamine	Stable Glutamine	Sodium pyruvate	Phenol red	HEPES	Special
P04-16500	x			x		
P04-16515	x					
P04-18047	x		x	x	10 mM	
P04-22100	x			x	25 mM	
P04-17598	x			x		
P04-17545	x			x		See above
P04-16598	x			x		See above
P04-19550	x			x	20 mM	See above

Liquid Media with stable Glutamine

RPMI 1640⁽¹⁾
with stable Glutamine
with 2.0 g/L NaHCO₃ 500 ml P04-18500

RPMI 1640⁽¹⁾
with stable Glutamine
with 25 mM HEPES
with 2.0 g/L NaHCO₃ 500 ml P04-18050

RPMI 1640⁽¹⁾
with stable Glutamine
without Phenol red
with 2.0 g/L NaHCO₃ 500 ml P04-16520

RPMI 1640⁽¹⁾
with stable Glutamine
without Phenol red
without Glucose
with 2.0 g/L NaHCO₃ 500 ml P04-16530

Special Media with stable Glutamine

RPMI 1640⁽²⁾
with stable Glutamine
without Glucose
with 2.0 g/L NaHCO₃ 500 ml P04-17546

Table for RPMI 1640 with stable Glutamine

	L-Glutamine	Stable Glutamine	Sodium pyruvate	Phenol red	HEPES	Special
P04-18500		x		x		
P04-18050		x		x	25 mM	
P04-16520		x				
P04-16530		x				
P04-17546		x		x		See above

- (1) usually on stock
- (2) minimum order 20 pieces
- (3) available upon request

Schneider`s Drosophila Medium

Description

Originally developed for the culture of Drosophila cells, this medium is also suitable for the culture of other dipteran cell lines.

Liquid Media

Schneider`s Drosophila Medium⁽¹⁾
without L-Glutamine
with 0.40 g/L NaHCO₃ 500 ml P04-90500

Schneider`s Drosophila Medium⁽¹⁾
with L-Glutamine
with 0.40 g/L NaHCO₃ 500 ml P04-91500

Powder Media

Schneider`s Drosophila Medium⁽¹⁾
without L-Glutamine 10 L P03-9310
without NaHCO₃ 50 L P03-9350

Composition

	Components	mg/L
Inorganic Salts	Calcium chloride x 2H ₂ O	790.00
	Potassium chloride	1,600.00
	Potassium dihydrogen phosphate	450.00
	Magnesium sulfate dried	2,585.71
	Sodium chloride	2,100.00
	di-Sodium hydrogen phosphate	700.00
Other Components	DL-Malic acid	600.00
	Succinic acid	60.00
	Fumaric acid	60.00
	D(+)-Glucose anhydrous	2,000.00
	Yeast extract	2,000.00
	α-Ketoglutaric acid sodium salt	402.66
	D(+)-Trehalose x 2H ₂ O	2,210.00
Amino Acids	β-Alanine	500.00
	L-Arginine base	600.00
	L-Aspartic acid	400.00
	L-Cysteine free base	60.00
	L-Cystine	16.60
	L-Glutamine	1,800.00
	L-Glutamic acid	800.00
	Glycine	250.00
	L-Histidine base	400.00
	L-Isoleucine	150.00
	L-Leucine	150.00
	L-Lysine x HCl	1,650.00
	L-Methionine	150.00
	L-Proline	1,700.00
	L-Serine	250.00
	L-Threonine	350.00
L-Tryptophan	100.00	
L-Tyrosine	500.00	
L-Valine	300.00	

(1) usually on stock

(2) minimum order 20 pieces

(3) available upon request

TC 100 Insect Medium

Description

The TC 100 Insect Medium is an absolutely serum-free formula (Oxford formulation) for the growth of insect cells, especially for SF9 cells and the breeding of viruses. If you would like to work with a modern protein-free insect medium, our Spodopan is the ideal choice.

Liquid Media

TC 100 Insect Medium⁽¹⁾
with L-Glutamine
with 0.35 g/L NaHCO₃ 500 ml P04-92500

Special Media

TC 100 Insect Medium⁽²⁾
without L-Glutamine
with 0.35 g/L NaHCO₃ 500 ml P04-93500

Powder Media

TC 100 Insect Medium⁽¹⁾
with L-Glutamine 10 L P03-9610
without NaHCO₃ 50 L P03-9650

Composition

	Components	mg/L
Inorganic Salts	Calcium chloride x 2H ₂ O	1,298.13
	Potassium chloride	2,900.00
	Magnesium chloride x 6H ₂ O	2,282.59
	Magnesium sulfate dried	1,781.00
	Sodium dihydrogen phosphate x H ₂ O	970.00
Other Components	D(+)-Glucose anhydrous	1,000.00
	Bacto-Tryptose	2,600.00
Amino Acids	L-Alanine	225.00
	L-Arginine Base	550.00
	L-Asparagine x H ₂ O	391.97
	L-Aspartic acid	350.00
	L-Cystine	20.00
	L-Glutamine	600.00
	L-Glutamic acid	600.00
	Glycine	650.00
	L-Histidine x HCl x H ₂ O	3,400.00
	L-Isoleucine	50.00
	L-Leucine	75.00
	L-Lysine x HCl	630.00
	L-Methionine	50.00
	L-Phenylalanine	150.00
	L-Proline	350.00
	L-Serine	550.00
L-Threonine	180.00	
L-Tryptophan	100.00	
L-Tyrosine	55.00	
L-Valine	100.00	
Vitamins	p-Amino benzoic acid	0.02
	D-(+)-Biotin	0.01
	D-Calcium pantothenate	0.11
	Folic acid	0.02
	myo-Inositol	0.02
	Nicotinic acid	0.02
	Pyridoxine x HCl	0.02
	Riboflavin	0.02
	Thiamine x HCl	0.02
	Vitamin B12	0.01

(1) usually on stock

(2) minimum order 20 pieces

(3) available upon request

TNM-FH Medium

Description

The TNM-FH is a variation of the Grace medium. This modification has proved as a good culture medium for many lepidopteran cells.

Liquid Media

TNM-FH Insect Medium⁽¹⁾
with L-Glutamine
with Lactalbumine Hydrolysate
with Yeast extract
with 0.35 g/L NaHCO₃ 500 ml P04-80500

Special Media

TNM-FH Insect Medium⁽²⁾
with L-Glutamine
with Lactalbumin Hydrolysate
with Yeast extract
with 10 % Fetal Bovine Serum
with 0.35 g/L NaHCO₃ 500 ml P04-83500

Powder Media

TNM-FH Insect Medium⁽¹⁾
without L-Glutamine
with Lactalbumine Hydrolysate
with Yeast extract 10 L P03-9710
without NaHCO₃ 50 L P03-9750

Composition

	Components	mg/L
Inorganic Salts	Calcium chloride x 2H ₂ O	1,324.62
	Potassium chloride	2,240.00
	Magnesium chloride x 6H ₂ O	2,278.86
	Magnesium sulfate dried di-Sodium hydrogen phosphate	1,939.80 876.92
Other Components	DL-Malic acid	670.00
	Succinic acid	60.00
	D-Fructose	400.00
	Fumaric acid	55.00
	D(+)-Glucose anhydrous	700.00
	Yeast extract	3,333.33
	α-Ketoglutaric acid sodium salt	425.66
	Lactalbumin Hydrolysate	3,333.33
	Sucrose	26,680.00
	Amino Acids	β-Alanine
L-Alanine		225.00
L-Arginine x HCl		700.00
L-Asparagine x H ₂ O		350.00
L-Aspartic acid		350.00
L-Cystine		19.18
L-Glutamine		600.00
L-Glutamic acid		600.00
Glycine		650.00
L-Histidine base		2,500.00
L-Isoleucine		50.00
L-Leucine		75.00
L-Lysine x HCl		625.00
L-Methionine		50.00
L-Phenylalanine		150.00
L-Proline		350.00
L-Serine		550.00
L-Threonine		175.00
L-Tryptophan	100.00	
L-Tyrosine	50.00	
L-Valine	100.00	
Vitamins	p-Aminobenzoic acid	0.02
	D-(+)-Biotin	0.01
	D-Ca-Pantothenate	0.02
	Choline chloride	0.20
	Folic acid	0.02
	myo-Inositol	0.02
	Nicotinic acid	0.02
	Pyridoxol x HCl	0.02
	Riboflavin	0.02
	Thiamine x HCl	0.02

(1) usually on stock

(2) minimum order 20 pieces

(3) available upon request

Waymouth`s MB 752/1 Medium

Description

Waymouth`s MB 752/1 Medium was developed for studies concerning nutrition and metabolism. It also can be used for growing strain L sub-lines, NCTC clone 929.

Special Media

Waymouth`s MB 752/1 Medium⁽²⁾
with L-Glutamine
with 2.24 g/L NaHCO₃ 500 ml P04-28500

Powder Media

Waymouth`s MB 752/1 Medium⁽¹⁾
with L-Glutamine 10 L P03-4510
without NaHCO₃ 50 L P03-4550

Composition

	Components	mg/L
Inorganic Salts	Calcium chloride x 2H ₂ O	120.02
	Magnesium chloride x 6H ₂ O	240.00
	Magnesium sulfate dried	130.96
	Potassium chloride	150.00
	Potassium dihydrogen phosphate	80.00
	Sodium chloride	6,000.00
	di-Sodium hydrogen phosphate anhydrous	300.00
Other Components	D(+)-Glucose anhydrous	5,000.00
	Glutathione (red.)	15.00
	Hypoxanthine	25.00
	Phenol red	10.00
Amino Acids	L-Arginine x HCl	75.00
	L-Aspartic acid	60.00
	L-Cysteine x HCl x H ₂ O	100.26
	L-Cystine	15.00
	L-Glutamine	350.00
	L-Glutamic acid	150.00
	Glycine	50.00
	L-Histidine x HCl x H ₂ O	164.10
	L-Isoleucine	25.00
	L-Leucine	50.00
	L-Lysine x HCl	240.00
	L-Methionine	50.00
	L-Phenylalanine	50.00
	L-Proline	50.00
	L-Threonine	75.00
L-Tryptophan	40.00	
L-Tyrosine	40.00	
L-Valine	65.00	
Vitamins	L-Ascorbic acid	17.50
	D(+)-Biotin	0.02
	D-Calcium pantothenate	1.00
	Choline chloride	250.00
	Folic acid	0.40
	myo-Inositol	1.00
	Nicotinamide	1.00
	Pyridoxine x HCl	1.00
	Riboflavin	1.00
	Thiamine x HCl	10.00
Vitamin B12	0.20	

(1) usually on stock

(2) minimum order 20 pieces

(3) available upon request

William`s Medium E

Description

The William`s Medium E is used for long-term cultivation of adult rat liver epithelial cells.

Liquid Media

William`s Medium E⁽¹⁾
without L-Glutamine
with 2.24 g/L NaHCO₃ 500 ml P04-29050

William`s Medium E⁽¹⁾
with L-Glutamine
with 2.24 g/L NaHCO₃ 500 ml P04-29500

William`s Medium E⁽¹⁾
with stable Glutamine
with 2.24 g/L NaHCO₃ 500 ml P04-29150

William`s Medium E⁽¹⁾
without L-Glutamine
without Phenol red
with 2.24 g/L NaHCO₃ 500 ml P04-29510

Special Media

William`s Medium E⁽²⁾
without L-Glutamine
without Glucose
with 2.24 g/L NaHCO₃ 500 ml P04-29050S1

Powder Media

William`s Medium E⁽¹⁾
with L-Glutamine
with 25 mM HEPES 10 L P03-4810
without NaHCO₃ 50 L P03-4850

Composition

	Components	mg/L
Inorganic Salts	Calcium chloride x 2H ₂ O	264.92
	Iron(III)-nitrat x 9H ₂ O	0.0001
	Potassium chloride	400.00
	Copper(II)-sulfate x 5H ₂ O	0.0001
	Magnesium sulfate anhydrous	97.67
	Manganese chloride x 4H ₂ O	0.0001
	Sodium chloride	6,800.00
	Sodium dihydrogen phosphate x H ₂ O	140.00
	Zinc sulfate x 7H ₂ O	0.0002
	Other Components	D(+)-Glucose anhydrous
HEPES		5,958.00
Glutathione (red.)		0.05
Methyl linoleat		0.03
Sodium pyruvate		25.00
Phenol red		10.00
Amino Acids	L-Alanine	90.00
	L-Arginine free base	50.00
	L-Asparagine x H ₂ O	20.00
	L-Aspartic acid	30.00
	L-Cysteine	40.00
	L-Cystine	20.00
	L-Glutamine	292.00
	L-Glutamic acid	50.00
	Glycine	50.00
	L-Histidine base	15.00
	L-Isoleucine	50.00
	L-Leucine	75.00
	L-Lysine x HCl	87.50
	L-Methionine	15.00
	L-Phenylalanine	25.00
	L-Proline	30.00
	L-Serine	10.00
L-Threonine	40.00	
L-Tryptophan	10.00	
L-Tyrosine	35.00	
L-Valine	50.00	
Vitamins	L-Ascorbic acid	2.00
	D(+)-Biotin	0.50
	Calciferol	0.10
	D-Calcium pantothenate	1.00
	Choline chloride	1.50
	Folic acid	1.00
	myo-Inositol	2.00
	Menadione sodium bisulfite	0.01
	Nicotinamide	1.00
	Pyridoxal x HCl	1.00
	Riboflavin	0.10
	Thiamine x HCl	1.00
	DL- α -Tocopherol phosphate-Na ₂	0.01
	Vitamin A acetate	0.10
	Vitamin B12	0.20

If 5,958.00 mg/L HEPES are included there are only 6,300.00 mg/L sodium chloride.

(1) usually on stock

(2) minimum order 20 pieces

(3) available upon request

Endopan

Background

Endothelial cells from blood and lymphatic vessels or the internal cavities of the heart play a key role in many physiological and patho-physiological processes. They display a strongly flattened, polygonal form and mostly rest on a basal membrane. They adhere to each other by desmosomes and tight-junctions.

With a total cell number of about one trillion (10^{12}), the endothelium is one of the biggest organs of the body and plays a key role in many physiological and patho-physiological processes (e.g. cell-based immune response, wound healing, inflammation, allergy, cardiovascular diseases, tumour growth). A huge number of soluble factors circulating in the blood or released by neighbouring cells, control proliferation or apoptosis of endothelial cells and the invasion and migration of leucocytes to the endothelium, thereby regulating the maintenance, degeneration, or regeneration of blood vessels.

The endothelium constitutes a highly specialized organ that lines the vascular system and lymphatic channels in a complex network of arteries, veins, and micro-vessels which differ in size, structure, and function. The cultivation of endothelial cells from large vessels, predominantly from human umbilical vein, is a routine procedure in many laboratories, and this has contributed huge to the development of modern vascular biology. However, there is convincing evidence that micro-vascular endothelial cells display a number of important functional differences, compared to large vessel-derived

endothelial cells, with regard to their growth factor response and their regulation of adhesion molecule expression.

They serve as the barrier separating circulating blood from the extracellular matrix and interstitium in the body. Cells involved in the pathogenesis of tumor angiogenesis, wound healing, and acute or chronic inflammation are predominantly of micro-vascular origin. Several functions associated with the micro-vasculature in situ are expressed by micro-vascular endothelial cells in cell culture.

Micro-vessels are not simply tubes but have also a second cellular component, the mural cell or pericyte. Little is known about later stages of vessel growth, including the addition of pericytes to the capillary and its influence on endothelial growth and function. In vivo, pericytes form an incomplete envelopment around the endothelial cells within the micro-vascular basement membrane of capillaries and post-capillary venules.

Evidence clearly indicates that differences exist between endothelial cells of the microvasculature and those that line large vessels. These include differences in secreted products, in the expression of cell adhesion molecules, and in cytokine-induced regulation of cell adhesion molecules. Thus, a precise delineation of the biology of micro-vascular endothelial cells is crucial to our understanding of such important processes as inflammation, tumor progression, cardiac microcirculation, and blood-brain barrier function.

Endopan 3

Large Vessel Endothelial Cell Medium

Endopan 3 ready-to-use ⁽¹⁾	500 ml	P04-00100
Endopan 3 kit with 9 supplements ⁽¹⁾	500 ml	P04-0010K

Composition

Endopan 3 ready-to-use is a specially developed medium for the in vitro culture of human endothelial cells containing all components necessary for optimal growth. It is designed for use in an incubator at 37° C with a 5% CO₂ atmosphere.

Endopan 3 kit is provided with FBS and supplements in separate sterile packing. This will enable the user to prepare a medium for special application. For example, FBS, VEGF, FGF-2, or other components may be omitted from the complete medium for specific experimental settings.

Endopan MV

Microvascular Endothelial Cell Medium

Endopan MV ready-to-use ⁽³⁾	500 ml	P04-00200
Endopan MV kit with 8 supplements ⁽³⁾	500 ml	P04-0020K

- (1) usually on stock
- (2) minimum order 20 pieces
- (3) available upon request

Endopan PRO

Endothelial Progenitor Medium

Background

Endothelial cells from blood and lymphatic vessels or the internal cavities of the heart play a key role in many physiological and patho-physiological processes. They display a strongly flattened, polygonal form and mostly rest on a basal membrane. With a total number of about 10^{12} cells, the endothelium is one of the biggest organs of the body and plays a key role in many physiological and patho-physiological processes. A number of factors control proliferation or apoptosis of endothelial cells, thereby regulating the maintenance, degeneration, or regeneration of blood vessels.

New blood vessel formation occurs via angiogenesis or vasculogenesis, a process thought to be restricted to embryonic development. In 1997, postnatal vasculogenesis has been proposed as an important mechanism for angiogenesis via blood or bone marrow derived circulating progenitor endothelial cells (PEC) (Asahara et al, Science 1997). Consequently, PECs have been extensively studied as a potential cell therapy for the repair of damaged blood vessels. Animal studies clearly demonstrated that administration of PECs partially rescued cardiovascular dysfunction or myocardial injury with evidence for PEC contribution to new vessel growth. In most studies, PECs are defined by cell surface expression of CD34, CD133, or VEGF-R2 (KDR). Because these molecules are also present on hematopoietic progenitors, relying only on surface markers can not exclude a contamination with hematopoietic lineage cells. More recently, a PEC population has been identified which shows expression of endothelial as well as progenitor, but not hematopoietic cell markers (Ingram et al, Blood. 2004;104:2752). Importantly, these cells have been tested for a high proliferative potential in clonogenic assays and additionally characterized by formation of functional blood vessels in vivo (Yoder et al, Blood. 2007;109:1801).

Composition

Endopan PRO ready-to-use is a complete medium specially developed for the in vitro culture of human progenitor endothelial cells (hPEC) containing all components necessary for optimal colony formation, clonogenic growth, and rapid proliferation.

Endopan PRO kit is provided with FBS growth supplement (pre-screened and tested for progenitor cells) and additional supplements in separate sterile packing. This will enable the user to prepare a medium for special application.

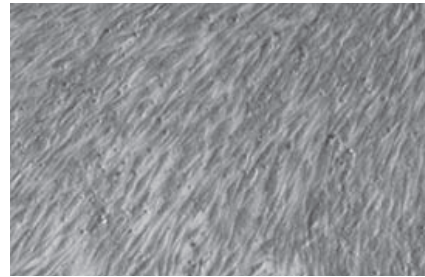

hPEC in Endopan PRO (P6)

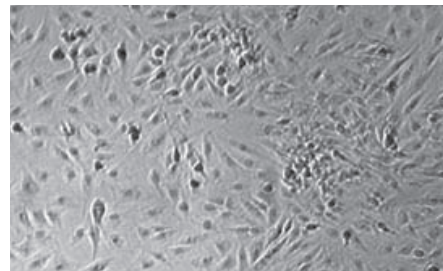

hPEC colony (P1) with outgrowing cells in Endopan PRO

Endopan PRO ready-to-use ⁽³⁾	500 ml	P04-00700
Endopan PRO kit with 6 supplements ⁽³⁾	500 ml	P04-0070K

(1) usually on stock

(2) minimum order 20 pieces

(3) available upon request

Pantum

Description

Pantum are ready-to-use growth media which contain purified plasma proteins and lipids, such as serum albumin and cholesterol, specific growth factors, components of soybean extract, an iron transport protein and enriched trace elements. The new formulations result in stable cell growth under defined culture conditions. No addition of serum or growth factors is necessary.

Pantum 386 for epithelial cells

Pantum 386 is a modified formulation of DMEM and specially developed to optimize the growth of epithelial cell lines.

Pantum 586A for adherent cells

Pantum 586A is particularly suited for culture of adherent cells to stimulate their growth. It is a modification of Iscove's MEM.

Pantum L24 for lymphocytes

Pantum L24 is suited for culture of peripheral blood lymphocytes. Adult lymphocytes lack the ability to proliferate. Therefore, Pantum L24 contains a mitogen (phytohemagglutinin, PHA) specifically acting on the cell cycle. It is a modified formulation of RPMI 1640.

Pantum T64 for tumor cells

Pantum T64 is specially developed for culture of tumor cells to stimulate the growth of this cell type. It is a modification of RPMI 1640.

Pantum 386 ⁽³⁾	500 ml	P04-00386
Pantum 586A ⁽³⁾	500 ml	P04-00586
Pantum L24 ⁽³⁾	500 ml	P04-00024
Pantum T64 ⁽³⁾	500 ml	P04-00064

Neuropan Neuronal Cell Medium

Neuropan Basal Medium

Neuropan basal medium supports the growth of hippocampus cells and many other neuronal cells of the central nervous system. A feeder layer of astrocytes is not required. Neuropan basal medium does not contain glutamate which should be added for the initial culture (25 μ M). Before use, Neuropan basal medium is supplemented with serum or for a serum-free culture with Neuropan 27 or NS21 Supplement.

Neuropan 27 is a concentrate for the serum-free cultivation of neural cells.

NS21 Supplement

To culture neurons in the absence of serum, defined supplements such as B27 are widely used. However, available supplements exhibit some variability in their capability to support neurons in culture. NS21 Supplement is a newly developed serum substitute for neuronal cultures of cells from the central and peripheral nervous system.

Neuropan-Basal Media (Basicmedia) ⁽²⁾	500 ml	P04-00900
Neuropan 27 supplement 20x ⁽²⁾	100 ml 10 ml	P07-07100 P07-07010
Neuropan 27 supplement 50x ⁽²⁾	100 ml 10 ml	P07-07200 P07-07210
Neuropan 2 supplement 100x ⁽²⁾	100 ml 10 ml	P07-11100 P07-11010
NS21 Supplement 50x sterile ⁽³⁾	10 ml	P07-20021
NS21 Supplement 50x non-sterile ⁽³⁾	10 ml	P07-20001

- (1) usually on stock
(2) minimum order 20 pieces
(3) available upon request

Stempan ES-Cell Medium

Description

Stem cells are non-specialized cells with the ability (potency) to develop into different organo-typic cell types (e. g. heart, nerve, blood, muscle and cartilage cells). Depending on their origin, they are divided into embryonic and adult stem cells.

Composition

For the cultivation of embryonic stem cells, PAN-Biotech has developed a complete ready-to-use medium. The medium contains fetal bovine serum.

Stempan DMEM ⁽²⁾ with L-Glutamine with 3.7 g/L NaHCO ₃ without LIF with FBS	500 ml	P08-50500
Stempan E14 GMEM ⁽²⁾ with L-Glutamine with 2.75 g/L NaHCO ₃ without LIF with FBS	500 ml	P08-50600

Mesenpan Special Medium for human Mesenchymal Stem Cells without FBS

Mesenpan	500 ml	P08-50400K (Kit)
----------	--------	------------------

EMEM Fibroblasts Fibroblast Medium

Description

Based on EMEM, this medium was supplemented with amino acids and vitamins and optimized for an improved growth of fibroblasts.

For the cultivation of fibroblasts, this medium has to be supplemented with 10% FBS before use.

EMEM Fibroblasts ⁽¹⁾	500 ml	P04-08049
---------------------------------	--------	-----------

- (1) usually on stock
(2) minimum order 20 pieces
(3) available upon request

Amniopan Prenatal Cytogenetics Medium

Description

Amniopan is a complete ready-to-use medium intended for in vitro diagnostic use with a short term culture of human fetal cells from amniotic fluid or chorion villi biopsy (CVS) material for a standardized application in cytogenetic studies.

Amniopan is intended for in vitro use and has been designed for establishing cultures of human fetal cells from amniotic fluid or chorion villi biopsies (CVS), which then can be used in karyotyping, fluorescence in-situ hybridisation (FISH) or other cytogenetic procedures.

Composition

Amniopan is supplied frozen as a complete medium, ready-to-use in a 100 ml format. It is based on alpha-MEM and contains antibiotics, L-glutamine, fetal bovine serum (FBS), hormones and growth factors.

Suitability

Amniopan is a complete medium (ready-to-use) for the cultivation of human fetal cells from amniotic fluid and chorion villi biopsy samples. It is suitable for a rapid expansion of amniotic cells in order to investigate chromosomal disorders. The number and quality of metaphases in Amniopan are significantly higher and independent of individual batches as compared to other media.

Amniopan ⁽¹⁾	100 ml	P04-70100
-------------------------	--------	-----------

Amniopan S2 Prenatal Cytogenetics Medium

Description

Amniopan S2 is a complete ready-to-use medium intended for in vitro diagnostic use with a short term culture of human fetal cells from amniotic fluid or chorion villi biopsy (CVS) material for a standardized application in cytogenetic studies.

Amniopan S2 is intended for in vitro use and has been designed for establishing cultures of human fetal cells from amniotic fluid or chorion villi biopsies (CVS), which then can be used in karyotyping, fluorescence in-situ hybridisation (FISH) or other cytogenetic procedures.

The media formulation of Amniopan S2 was further optimized on human fetal cells from amniotic fluid and CVS, with special emphasis on fast attachment of cells to the cell culture substrate and efficient cell growth to facilitate rapid diagnostic findings.

Composition

Amniopan S2 is supplied frozen as a complete medium, ready-to-use in a 100 ml format. It is based on alpha-MEM and contains antibiotics, L-glutamine, fetal bovine serum (FBS), hormones and an increased amount of growth factors.

Suitability

Amniopan S2 is a ready-to-use medium for the cultivation of human fetal cells from amniotic fluid and chorion villi biopsy samples. It is suitable for a rapid expansion of amniotic cells in order to investigate chromosomal disorders. The number and quality of metaphases in Amniopan S2 are significantly higher and independent of individual batches as compared to other media.

Amniopan S2 ⁽¹⁾	100 ml	P04-70101
----------------------------	--------	-----------

Amniopan III Prenatal Cytogenetics Medium

Description

Amniopan III is a complete ready-to-use medium intended for in vitro diagnostic use with a short term culture of human fetal cells from amniotic fluid or chorion villi biopsy (CVS) material for a standardized application in cytogenetic studies.

The **NEW developed media formulation** of Amniopan III is optimal to facilitate rapid diagnostic findings.

Suitability

Amniopan III is a ready-to-use medium for the cultivation of human fetal cells from amniotic fluid and chorion villi biopsy samples. It is suitable for a rapid expansion of amniotic cells in order to investigate chromosomal disorders.

Amniopan III ⁽¹⁾	100 ml	P04-70103
-----------------------------	--------	-----------

- (1) usually on stock
- (2) minimum order 20 pieces
- (3) available upon request

Marrowpan

Marrow Cell Medium

Description

Marrowpan is a complete ready-to-use medium intended for in vitro diagnostic procedures with a short term culture of bone marrow and other hematopoietic cells for cytogenetic studies.

Marrowpan is intended for in vitro use and has been designed for establishing cultures of bone marrow and leukemic blood cells, which then can be used in karyotyping, fluorescence in-situ hybridisation (FISH) or other cytogenetic procedures.

Marrowpan can be used as a neutral medium to culture different haematopoietic cells (myeloid and lymphoid lineages) present in bone marrow or leukemic blood samples. Marrowpan is also used together with a mitogen specific for B or T lymphocytes where these particular lineages are being investigated.

Composition

Marrowpan is supplied frozen as a complete medium, ready-to-use in a 100 ml format. It is based on alpha-MEM and contains antibiotics, L-glutamine, fetal bovine serum (FBS), hormones and growth factors.

Suitability

Marrowpan is a complete medium (ready-to-use) for the cultivation of cells from peripheral blood or bone marrow. It is suitable for a rapid expansion of blood cells in order to investigate leukemic diseases (e.g. ALL, AML, CLL, CML, MPN, MDS). The number and quality of metaphases in Marrowpan are significantly higher and independent of individual batches as compared to serum-containing media.

Marrowpan ⁽¹⁾	100 ml	P04-70200
--------------------------	--------	-----------

Marrowpan S2

Marrow Cell Medium

Description

Marrowpan S2 is a complete ready-to-use medium intended for in vitro diagnostic procedures with a short term culture of bone marrow and other hematopoietic cells for cytogenetic studies. Marrowpan S2 is intended for in vitro use and has been designed for establishing cultures of bone marrow and leukemic blood cells, which then can be used in karyotyping, fluorescence in-situ hybridisation (FISH) or other cytogenetic procedures.

Marrowpan S2 can be used as a neutral medium to culture different haematopoietic cells (myeloid and lymphoid lineages) present in bone marrow or leukemic blood samples. Marrowpan S2 is also used together with a mitogen specific for B or T lymphocytes where these particular lineages are being investigated.

Composition

Marrowpan S2 is supplied frozen as a complete medium, ready-to-use in a 100 ml format. It is based on alpha-MEM and contains antibiotics, L-glutamine, Fetal Bovine Serum (FBS), hormones and an increased amount of growth factors.

Suitability

Marrowpan S2 is a ready-to-use medium for the cultivation of cells from peripheral blood or bone marrow. It is suitable for a rapid expansion of blood cells in order to investigate leukemic diseases (e.g. ALL, AML, CLL, CML, MPN, MDS). The number and quality of metaphases in Marrowpan S2 are significantly higher and independent of individual batches as compared to serum-containing media.

Marrowpan S2 ⁽¹⁾	100 ml	P04-70201
-----------------------------	--------	-----------

(1) usually on stock

(2) minimum order 20 pieces

(3) available upon request

Reagents

Introduction	109
Media Supplements	110
Buffered Salt Solutions	111
Amino Acids and Vitamins	116
Antibiotics and Antifungal Drugs	117
Mycorase	118
Collagenases	119
Accutase	119
Accumax	120
Trypsin and others	121
Collagen A	122
Collagen R (type I)	122
Gelatine Solution	122
Laminin Mouse	123
Fibronectin	123
Pancoll	124
Separating Solutions Pre-Filled	125
DMSO	126
Freezing Medium	126
Cryopan I	126
Bovine Serum Albumin / Human Serum Albumin	127

Introduction

PAN-Biotech manufactures and supplies a wide range of high quality reagents for use in cell culture. These reagents are supplied as a separate product group for use in conjunction with PAN-Biotech serum products, cell culture media and buffer solutions. All PAN-Biotech reagents are tested under highest quality standards. Hence, all liquid reagents are sterilized and filtered at 0.2 µm. Our goal is to provide you with high quality products that are consistent from batch to batch.

Packaging

All liquid reagents are sterile filtered into gamma irradiated PET bottles. All reagents supplied in powder form are filled into convenient sized containers.

Storage

Exact storage conditions are shown on each product label and in the product specification as shown in this catalogue. Please ensure you take careful note of the storage conditions to ensure product integrity.

All products are subject to a final quality control check before being packaged and despatched.

Media Supplements

Description**Maximum efficiency without loss of quality**

PAN-Biotech reagents are tested according to the highest possible quality standards. All liquid reagents are dissolved according to in-house specifications, sterilized

and filtered at 0.2 µm. Before final release, the reagents undergo extensive quality tests e. g. sterility, pH value, osmo.

Different Media Supplements

HAT supplement (50x) ⁽¹⁾	100 ml	P07-02100
HT supplement (50x) ⁽¹⁾	100 ml	P07-01100
HEPES buffer 1M ⁽¹⁾	100 ml 500 ml	P05-01100 P05-01500
HEPES ⁽¹⁾	100 g 500 g	P05-01100P P05-01500P
Sodium bicarbonate 7.5 % ⁽¹⁾	100 ml	P04-44100
Sodium pyruvate 100 mM ⁽¹⁾	100 ml	P04-43100
ITS Solution I (100x) ⁽¹⁾	5 ml 10 ml	P07-03100 P07-03110
ITS Solution II (100x) ⁽¹⁾	5 ml 10 ml	P07-03200 P07-03210
ITS solution IV (100x) ⁽³⁾ (w: Linoleic acid, BSA)	5 ml 10 ml	P07-03400 P07-03410
Insulin human rec. 10 mg/ml solution ⁽¹⁾	10 ml	P07-04300
Insulin human recombinant ⁽¹⁾	100 mg	P07-04200
Sterile Water for cell culture ⁽¹⁾	500 ml 1 L 20 L	P04-991500 P04-991000 P04-992000
β-Mercapthoethanol 50 mM in PBS ⁽¹⁾	20 ml 100 ml	P07-05020 P07-05100
Pluronic F-68 10 % ⁽¹⁾	100 ml	P08-02100
Human Transferrin apo ⁽¹⁾	100 mg 500 mg 1 g	P06-21100 P06-21500 P06-21000
Demecolcine Solution 10 µg/ml ⁽¹⁾	10 ml	P07-91010
Sodium Chloride Solution 0.9 % ⁽¹⁾	500 ml	P05-39500

- (1) usually on stock
 (2) minimum order 20 pieces
 (3) available upon request

Buffered Salt Solutions

Dulbecco`s Phosphate Buffered Salt Solution

Composition

	Components	mg/L
Inorganic Salts	Potassium chloride	200.00
	Potassium dihydrogen phosphate	200.00
	Sodium chloride	8,000.00
	di-Sodium hydrogen phosphate anhydrous	1,150.00
	Calcium chloride x 2H ₂ O	133.00
	Magnesium chloride x 6H ₂ O	100.00

Earl`s Buffered Salt Solution

Composition

	Components	mg/L
Inorganic Salts	Potassium chloride	400.00
	Sodium chloride	6,800.00
	Sodium dihydrogen phosphate x H ₂ O	140.00
	Calcium chloride x 2H ₂ O	264.92
	Magnesium sulfate x 7H ₂ O	200.00
Other Components	D(+)-Glucose anhydrous	1,000.00
	Phenol red	10.00

Liquid Salt Solution

DPBS ⁽¹⁾ without Ca and Mg	500 ml	P04-36500
	1 L	P04-361000
	2.5 L	P04-3625C
	5 L	P04-3650C
	10 L	P04-360010B

DPBS (10x) ⁽¹⁾ without Ca and Mg	500 ml	P04-53500
--	--------	-----------

DPBS non-sterile ⁽¹⁾ without Ca and Mg	2.5 L	P04-362500
	10 L	P04-360000

DPBS ⁽¹⁾ with Ca and Mg	500 ml	P04-35500
---------------------------------------	--------	-----------

DPBS (10x) ⁽²⁾ with Ca and Mg	500 ml	P04-37500
---	--------	-----------

Powder

DPBS ⁽¹⁾ without Ca and Mg	50 L	P04-36050P
--	------	------------

Liquid Salt Solution

EBSS ⁽²⁾	500 ml	P04-30500
---------------------	--------	-----------

EBSS ⁽²⁾ without Phenol red	500 ml	P04-39500
---	--------	-----------

EBSS ⁽²⁾ without Ca and Mg with 2.2 g/L NaHCO ₃	500 ml	P04-31500
---	--------	-----------

EBSS (10x) ⁽³⁾	500 ml	P04-38500
---------------------------	--------	-----------

EBSS (10x) ⁽³⁾ without Ca and Mg without Phenol red	500 ml	P04-47500
--	--------	-----------

Powder

EBSS ⁽¹⁾	10 L	P04-30010P
	50 L	P04-30050P

(1) usually on stock
 (2) minimum order 20 pieces
 (3) available upon request

Buffered Salt Solutions

Hank`s Balanced Salt Solution

Composition

	Components	mg/L
Inorganic Salts	Potassium chloride	400.00
	Sodium chloride	8,000.00
	di-Sodium hydrogen phosphate anhydrous	47.88
	Calcium chloride x 2H ₂ O	185.44
	Magnesium sulfate dried	139.52
	Potassium dihydrogen phosphate	60.00
Other Components	D(+)-Glucose anhydrous	1,000.00
	Phenol red	10.00

Hank`s Balanced Salt Solution

Liquid Salt Solution

HBSS ⁽²⁾	100 ml	P04-32100
with 0.35 g/L NaHCO ₃	500 ml	P04-32500
HBSS (10x) ⁽²⁾	100 ml	P04-49100
without NaHCO ₃	500 ml	P04-49500
HBSS ⁽¹⁾		
without Ca and Mg	100 ml	P04-33100
with 0.35 g/L NaHCO ₃	500 ml	P04-33500
HBSS (10x) ⁽¹⁾		
without Ca and Mg	100 ml	P04-50100
without NaHCO ₃	500 ml	P04-50500
HBSS ⁽¹⁾		
without Phenol red	100 ml	P04-32105
with 0.35 g/L NaHCO ₃	500 ml	P04-32505
HBSS (10x) ⁽²⁾		
without Phenol red	100 ml	P04-49105
without NaHCO ₃	500 ml	P04-49505
HBSS ⁽¹⁾		
without Ca and Mg		
without Phenol red	100 ml	P04-34100
with 0.35 g/L NaHCO ₃	500 ml	P04-34500
	1 L	P04-341000
HBSS (10x) ⁽²⁾		
without Ca and Mg		
without Phenol red	100 ml	P04-50105
without NaHCO ₃	500 ml	P04-50505
Powder		
HBSS ⁽¹⁾		
without NaHCO ₃	10 L	P04-32010P
	50 L	P04-32050P
HBSS ⁽¹⁾		
without Ca and Mg	10 L	P04-33010P
without NaHCO ₃	50 L	P04-33050P

(1) usually on stock
 (2) minimum order 20 pieces
 (3) available upon request

Buffered Salt Solutions

Puck's Salt Solution A

Composition

	Components	mg/L
Inorganic Salts	Potassium chloride	400.00
	Sodium chloride	8,000.00
Other Components	D(+)-Glucose anhydrous	1,000.00
	Phenolred	5.00
	NaHCO ₃	350.00

Liquid Salt Solution

Puck's Salt Solution A⁽²⁾ 100 ml P04-51100
500 ml P04-51500

Tyrode's Salt Solution

Composition

	Components	mg/L
Inorganic Salts	Potassium chloride	200.00
	Sodium chloride	8,000.00
	Magnesium chloride anhydrous	100.00
	Calcium chloride anhydrous	200.00
	Sodium phosphate monobasic	50.00
Other Components	D(+)-Glucose anhydrous	1,000.00

Liquid Salt Solution

Tyrode's Salt Solution⁽²⁾ 500 ml P04-54500

Powder

Tyrode's Salt Solution⁽¹⁾ 10 L P04-54010P
without NaHCO₃ 50 L P04-54050P

Gey's Balanced Salt Solution

Composition

	Components	mg/L
Inorganic Salts	Potassium chloride	370.00
	Sodium chloride	7,000.00
	di-Sodium hydrogen phosphate	120.00
	Calcium chloride x 2H ₂ O	225.10
	Magnesium chloride x 6 H ₂ O	210.00
	Magnesium sulfate anhydrous	34.20
	Potassium dihydrogen phosphate anhydrous	30.00
Other Components	D(+)-Glucose anhydrous	1,000.00

Liquid Salt Solution

GBSS⁽¹⁾ 500 ml P04-48500
with 2.27 g/L NaHCO₃

Powder

GBSS⁽¹⁾ 10 L P04-48010P
without NaHCO₃ 50 L P04-48050P

(1) usually on stock
(2) minimum order 20 pieces
(3) available upon request

Buffered Salt Solutions

Erythrolyse Buffer 1x

NEW !**Application**

Removal of red blood cells (RBCs) from samples is a necessary step prior to flow cytometric analysis, immunophenotyping, immunofluorescence staining, cell culture, cryospin, cytogenetics and cell sorting.

Composition

This buffer contains ammonium chloride NH_4Cl , which lyses red cells with minimal effect on lymphocytes when used as instructed. Other components are potassium hydrogencarbonate and Titriplex II (=EDTA). Erythrocyte Lysis Buffer 1x is sterile filtered (0.2 μm) and contains no fixative and no preservatives.

Procedure

1. Collect whole blood by venipuncture in EDTA- or heparin-treated collection tubes
2. Aliquot 1ml blood into 15 ml conical centrifuge tube
3. Add 8 ml lysing solution to tube
4. Gently mix the cells and incubate for 15-20 minutes at room temperature. Lysis of the red cells should be evident during this incubation. Wait until the liquid is clear red.
5. Centrifugation at 400 x g for 5 minutes.
6. Aspirate the supernatant, avoid disturbing the pellet.
7. Resuspend cells by raking gently across a tube rack.
8. Collect all pellets and
9. wash cells with 5 ml cold Buffer (e.g. Hank's Balanced Salt Solution or PBS/1% FBS).
10. Spin, decant, and resuspend.
11. The cells are ready for further analysis

Erythrolyse Buffer 1x ⁽¹⁾**NEW !**100 ml
500 mlP10-90100
P10-90500

- (1) usually on stock
- (2) minimum order 20 pieces
- (3) available upon request

Amino Acids and Vitamins

Amino Acids

BME Amino Acids Solution (50x), without L-Glutamine ⁽³⁾	100 ml	P08-2000
L-Glutamine 200 mM ⁽¹⁾	50 ml 100 ml	P04-80050 P04-80100
Stable L-Glutamine 200 mM ⁽¹⁾ (L-Alanyl-L-Glutamine)	50 ml 100 ml	P04-82050 P04-82100
L-Glutamine ⁽¹⁾ Powder	25 g 100 g 500 g	P04-80025P P04-80100P P04-80500P
Stable Glutamine Powder ⁽¹⁾ (L-Alanyl-L-Glutamine)	10 g	P04-82010P
MEM Amino Acids Solution (50x), without L-Glutamine ⁽¹⁾	100 ml	P08-30100
MEM Amino Acids Solution (50x), with L-Glutamine ⁽³⁾	100 ml	P08-31100
MEM NEAA (100x) ⁽¹⁾	100 ml	P08-32100

Vitamins

BME Vitamin Solution (100x) ⁽³⁾	100 ml	P08-40100
MEM (100x) Vitamin Solution (100x) ⁽¹⁾	100 ml	P08-41100

- (1) usually on stock
(2) minimum order 20 pieces
(3) available upon request

Antibiotics and Antifungal Drugs

Product	Size	Product No.	Recommended concentration
Amphotericin B ⁽¹⁾ 250 µg/ml	50 x 1 ml 50 x 5 ml 50 ml 100 ml	P06-01001 P06-01005 P06-01050 P06-01100	10 ml/L
Amphotericin B ⁽¹⁾ Powder	50 mg 100 mg	P06-01050P P06-01100P	
Amphotericin B water soluble ⁽¹⁾ Powder	25 mg 50 mg	P06-01225P P06-01250P	
Bacitracin ⁽¹⁾ Powder	10 g 25 g	P06-02010P P06-02025P	
Gentamicin sulfate ⁽¹⁾ 10 mg/ml	50 x 1 ml 50 x 5 ml 50 ml 100 ml	P06-03001 P06-03005 P06-03050 P06-03100	5 ml/L
Gentamicin sulfate ⁽²⁾ 50 mg/ml	50 x 1 ml 50 x 5 ml 50 ml 100 ml	P06-13001 P06-13005 P06-13050 P06-13100	1 ml/L
Gentamicin sulfate ⁽¹⁾ Powder	1 g 10 g 25 g	P06-03001P P06-03010P P06-03025P	
Hygromycin B 50 mg/ml ⁽²⁾	20 ml 100 ml	P06-08020 P06-08100	4 - 8 ml/L
Hygromycin B ⁽¹⁾ Powder	50 mg 1 g	P06-080050P P06-080100P	
Kanamycin sulfate ⁽²⁾ 5 mg/ml	50 x 1 ml 50 x 5 ml 50 ml 100 ml	P06-04001 P06-04005 P06-04050 P06-04100	20 ml/L
Kanamycin sulfate ⁽¹⁾ 10 mg/ml	50 x 1 ml 50 x 5 ml 50 ml 100 ml	P06-14001 P06-14005 P06-14050 P06-14100	10 ml/L
Kanamycin sulfate ⁽²⁾ 50 mg/ml	50 x 1 ml 50 x 5 ml 50 ml 100 ml	P06-15001 P06-15005 P06-15050 P06-15100	2 ml/L
Kanamycin sulfate ⁽¹⁾ Powder	10 g 50 g	P06-04010P P06-04050P	
Minocyclin 0.5 mg/ml ⁽³⁾	50 ml 100 ml	P06-05050 P06-05100	10 ml/L
Mycorase ⁽¹⁾	100 ml	P06-02100	20 ml/L
Neomycin sulfate ⁽³⁾ 10 mg/ml	50 ml 100 ml	P06-06050 P06-06100	5 ml/L
Neomycin sulfate ⁽¹⁾ Powder	10 g 25 g 100 g	P06-06010P P06-06025P P06-06100P	
Nystatin Solution ⁽²⁾ 10,000 Units/ml	100 ml	P06-07800	

- (1) usually on stock
- (2) minimum order 20 pieces
- (3) available upon request

Antibiotics and Antifungal Drugs

Product	Size	Product No.	Recommended concentration
Paneticin 420 50 mg/ml ⁽³⁾	20 ml 100 ml	P06-16020 P06-16100	2 ml/L - 16 ml/L
Paneticin G418 50 mg/ml ⁽³⁾	20 ml	P06-16220	2 ml/L - 16 ml/L
Paneticin 420 Powder ⁽¹⁾	1 g 5 g 10 g	P06-16001P P06-16005P P06-16010P	
Penicillin/Streptomycin ⁽¹⁾ 10,000 Units Penicillin/ml 10 mg Streptomycin/ml	50 x 1 ml 50 x 5 ml 50 ml 100 ml	P06-07001 P06-07005 P06-07050 P06-07100	10 ml/L
Penicillin/Streptomycin/Amphotericin B Mix ⁽¹⁾ 10,000 Units Penicillin/ml 10 mg Streptomycin/ml 25 µg Amphotericin B/ml in 0.85 % saline	50 x 1 ml 50 x 5 ml 50 ml 100 ml	P06-07301 P06-07305 P06-07350 P06-07300	10 ml/L
Penicillin G potassium salt Powder ⁽¹⁾	25 g 100 g	P06-08025P P06-08100P	
Streptomycin sulfate Powder ⁽¹⁾	25 g 50 g 100 g	P06-11025P P06-11050P P06-11100P	
Polymyxin B sulfate 10,000 Units/ml ⁽³⁾	50 ml	P06-09050	10 ml/L
Tiamulin 1 mg/ml ⁽³⁾	50 x 1 ml 50 x 5 ml 50 ml 100 ml	P06-12001 P06-12005 P06-12050 P06-12100	

Mycorase

Description

Mycorase has been developed to remove a broad range of different strains of mycoplasma in most cell types. Mycorase is easy to use and does not affect eukaryotic cell proliferation. It is a highly effective antibiotic solution for safe eradication of mycoplasma contamination.

Special advantages

- Ready-to-use solution
- Effective removal of mycoplasma
- No effect on cell proliferation
- Broad range of action
- Permanent cure for most cell types

Mycorase ⁽¹⁾	100 ml	P06-02100
-------------------------	--------	-----------

(1) usually on stock
(2) minimum order 20 pieces
(3) available upon request

Enzymes for Cell Dissociation

Collagenase type I

Natural balance of enzyme activity. Recommended for cell preparation from epithelial lung tissue, tissue of the suprarenal gland and adipose tissue. Store at 2 – 8° C.

Collagenase type II

With especially high activity of clostripain and trypsin. Recommended for cell preparation from liver tissue, bone tissue, cardiac tissue, thyroid gland tissue and salivary gland tissue. Store at 2 – 8° C.

Collagenase type III

Normal collagenase activity with a minimum of proteolytic activity. Especially recommended for breast tissue. Store at 2 – 8° C.

Collagenase type IV

Selected low tryptic activity at high collagenase activity and normal clostripain level. Recommended for cell preparation from the pancreatic island. Store at 2 – 8° C.

Collagenase type I (Worthington - USA origin)	100 mg 1 g	LS0004194 LS0004196
Collagenase type II (Worthington - USA origin)	100 mg 1 g	LS0004174 LS0004176
Collagenase type III (Worthington - USA origin)	100 mg 1 g	LS0004180 LS0004182
Collagenase type IV (Worthington - USA origin)	100 mg 1 g	LS0004186 LS0004188

Accutase

Description

Accutase is a ready-to-use cell detachment solution made of collagenolytic and proteolytic enzymes. It is used for routine detachment of adherent cells from tissue culture plates and flasks. A multitude of cell types has been successfully sub-cultured with Accutase, including fibroblasts, endothelial, vascular smooth muscle cells, as well as hepatocytes, embryonal stem cells, and many immortalized cell lines such as adherent CHO and BHK cells, HEK 293, L929, HeLa, 3T3, and others. Accutase is free of mammalian or bacterial products.

Composition

Accutase enzymes (activity > 500 U/ml) in DPBS w/o Ca/Mg with 0.5 mM EDTA and phenol red.

Suitability

Accutase can be used as a direct replacement of trypsin for cell dissociation.

Special advantages

Neutralizing of the Accutase enzymes is not required for routine cell culture passaging. The product is active at room temperature, no pre-warming required or recommended. Gentle detachment of cells for analysis of cell surface markers, transfection procedures, migration or proliferation assays, flow cytometry, and routine cell passage.

Accutase ⁽¹⁾	100 ml 500 ml	P10-21100 P10-21500
-------------------------	------------------	------------------------

Accutase is a registered trademark of Innovative Cell Technologies, Inc.
Accutase is manufactured under license from Innovative Cell Technologies.

- (1) usually on stock
- (2) minimum order 20 pieces
- (3) available upon request

Enzymes for Cell Dissociation

Accumax

NEW !

Description

Accumax is a ready-to-use solution of proteolytic and collagenolytic enzymes. It is used for creating single cell suspensions from clumped cell cultures for accurate cell counting, dissociation of spheroids into single cell suspensions, extension of sort times of clumpy cell samples on a fluorescence activated cell sorter, removal of cells from primary tissue and the routine detachment of cells from standard tissue culture plasticware and adhesion coated plasticware.

Cell lines tested for Accumax applications include fibroblasts, keratinocytes, vascular endothelial cells, hepatocytes, vascular smooth muscle cells, hepatocyte progenitors, primary chick embryo neuronal cells, bone marrow stem cells, adherent CHO and BHK cells, macrophages, 293 cells, L929 cells, immortalized mouse testicular germ cells, MRC5, 3T3, Vero, COS, HeLA, NT2, MG63, M24 and A375 metastatic melanoma, gliomas U251, D54, HT1080 fibrosarcoma cells, Sf9 insect cells, human Accumax contains no mammalian or bacterial derived products.

Composition

Accumax enzymes (activity 1200 - 2000 U/ml) in DPBS w/o Mg^{2+}/Ca^{2+} , with 0.5 mM EDTA.

Suitability

Accumax can be used as a direct replacement of trypsin for cell detachment or collagenase for cell dissociation or as an anti-clumping agent for cell culture, flow cytometry, and FACS.

Special advantages

- Ready-to-use solution
- Neutralizing of the Accumax enzymes is not required for routine cell culture passaging.
- The product is active at room temperature, no pre-warming required or recommended.
- Preserves most epitopes for subsequent flow cytometry analysis.
- Gentle detachment of cells for analysis of cell surface markers, transfection procedures, migration or proliferation assays, flow cytometry, and routine cell passage.

Accumax⁽³⁾

NEW !

100 ml
500 mlP10-21200
P10-21250

Enzymes for Cell Dissociation

Trypsin and others

Application

For dissociation of tissue and cell monolayer cultures.

Shelf life

Solution 24 months, powder 36 months.
The shelf life commences with date of production.

Our trypsin is tested negative for mycoplasma and PPV.

Storage

Solution at -20° C, powder at 2 - 8° C.

Other sizes and custom formulation

Please ask for other sizes or special formulations of trypsin; in most cases we can provide a solution.

Trypsin 0.25 %/EDTA 0.02 % in PBS ⁽¹⁾ without Ca and Mg with Phenol red	100 ml 500 ml	P10-019100 P10-019500
Trypsin 0.25 %/EDTA 0.02 % in PBS ⁽¹⁾ without Ca and Mg	100 ml 500 ml	P10-020100 P10-020500
Trypsin 0.25 % in PBS ⁽¹⁾ without Ca and Mg	100 ml 500 ml	P10-021100 P10-021500
Trypsin 2.5 % in PBS ⁽²⁾ without Ca and Mg	100 ml 500 ml	P10-022100 P10-022500
Trypsin 0.05 %/EDTA 0.02 % in PBS ⁽¹⁾ without Ca and Mg	100 ml 500 ml	P10-023100 P10-023500
Trypsin 0.05 %/EDTA 0.02 % in PBS ⁽¹⁾ without Ca and Mg with Phenol red	100 ml 500 ml	P10-0231SP P10-0235SP
(10x) Trypsin 0.5 %/EDTA 0.2 % in PBS ⁽²⁾ without Ca and Mg	100 ml 500 ml	P10-024100 P10-024500
Trypsin 0.05 %/EDTA 0.1 % in PBS ⁽²⁾ without Ca and Mg	100 ml 500 ml	P10-027100 P10-027500
Trypsin 0.25 %/1 mM EDTA 4 Na in PBS ⁽¹⁾ without Ca and Mg	100 ml	P10-028100
Trypsin 0.25 %/1 mM EDTA in HBSS ⁽¹⁾ without Ca and Mg with Phenol red	100 ml 500 ml	P10-029100 P10-029500
Trypsin 0.05 %/EDTA 4 Na 0.02 % in HBSS ⁽²⁾ without Ca and Mg with Phenol red	100 ml 500 ml	P10-040100 P10-040500
Trypsin special solution (for ES-cells) ⁽¹⁾	100 ml	P10-100100
Trypsin Inhibitor 1 mg/ml ⁽¹⁾	100 ml	P10-033100
Trypsin powder (1:250) porcine origin ⁽¹⁾	25 g 100 g 500 g	P10-025025P P10-025100P P10-025500P
EDTA 1 % in PBS without Ca and Mg ⁽²⁾	100 ml 500 ml	P10-026100 P10-026500
Dispase II neutral proteins, grade II ^{(1) *}	100 ml	P10-032100
Dispase purified neutral protease ⁽³⁾	10 mg	LS0002100

* Shelf life of Dispase II: 2 months after production day

- (1) usually on stock
- (2) minimum order 20 pieces
- (3) available upon request

Attachment Factors

Collagen A

0.1 % Collagen A solution, 1 mg/ ml

in HCl, type 1

For coating culture flasks with monomeric Collagen A

Collagen A	1 x (6 x 5 ml)	P06-20030
------------	----------------	-----------

Collagen R (type I)

0.2 % sterile solution

Type 1 rat tail collagen; 2 mg/ml in 0.1 % acetic acid.
Excellent substrate for the culture of hepatocytes,
fibroblasts and epithelial cells.

0.4 % sterile solution

Type 1 rat tail collagen; 4 mg/ml in 0.1 % acetic acid.
Excellent substrate for the culture of hepatocytes,
fibroblasts and epithelial cells.

Collagen R 0.2 % sterile solution	20 ml 100 ml	P06-20166 P06-20100
Collagen R 0.4 % sterile solution	20 ml	P06-20020

Gelatine Solution

Description

The gelatine solution is used for coating cell culture dishes. It is applied in adherent cell cultures working with e.g. endothelial cells or ES-cells.

Gelatine solution 0.1 % in PBS ⁽¹⁾	500 ml	P06-20410
Gelatine solution 2 % in PBS ⁽²⁾	100 ml	P06-25200

- (1) usually on stock
- (2) minimum order 20 pieces
- (3) available upon request

Attachment Factors

Laminin Mouse

Description

This highly purified preparation of mouse Laminin I increases cell adhesion, migration, growth, and differentiation. It is composed of 111 chains with a total MW of 800 kD and is used for the coating of culture dishes.

Source:

Murine Engelbreth-Holm-Swarm (EHS) tumor

Storage Buffer:

Dulbecco's Modified Eagle's Medium with 10 µg/ml gentamycin sulfate

Storage:

Store at -20° C or at -80° C in a manual defrost freezer

Purity:

Purity > 90 % by SDS-PAGE

Specifications

Functional assays

- Supports the formation of neuronal filaments of NG108-15 cells in a neurite outgrowth assay

Sterility testing

- No bacterial or fungal growth detected after incubation at 37° C for 14 days following USP XXIV, Chapter 71 sterility testing
- No mycoplasma contamination detected by PCR
- Endotoxin concentrations < 20 EU/ml by LAL assay

Coating procedure

The recommended working concentration is 0.05 - 10 µg/cm² of growth surface (0.05 - 10 µg/ml) depending on cell type.

a. Thaw stock solution on ice for several hours. Place plates on ice and pre-chill pipette tips. Distribute the solution to completely cover the bottom of the wells.

b. The following table gives suggested volume required per well:

Plate Type	Volume Laminin per Well
6 wells (or 35 mm dish)	1 ml
24 wells	200 µl
48 wells	50 µl
96 wells	20 µl

c. Incubate the plates at 37° C for 1 hour. In the laminar flow hood, remove excess liquid from the wells of the tissue culture plate.

Rinse the wells once with tissue culture medium and then add your cells.

Laminin from mouse	1 mg	P06-20501
--------------------	------	-----------

Fibronectin

Description

Fibronectin is a large glycoprotein widely distributed in soluble form in the plasma and body fluids. Many cell types synthesize fibronectin. There is also an insoluble form of fibronectin in tissues. Plasma fibronectin is not identical to cellular fibronectin but equally effective in supporting cell attachment. Fibronectin promotes the attachment and spreading of many adherent cells on plastic, but also mediates binding to other extracellular matrix components such as e.g. collagen.

Preparation

Fibronectin is purified from human plasma; donors tested negative for anti-HIV antibodies and HBs antigen.

Reconstitution

Dissolve contents in sterile water. Prepare a 1 mg/ml solution by gently warming the vial to 37° C; do not agitate, this may cause precipitation.

Recommended amount for coating

For coating of cell culture vessels 1-5 µg/cm² is used.

Storage

Lyophilisate can be stored at 2-8° C; solution stored at -20° C in aliquots.

Fibronectin	5 mg	2705005
Fibronectin solution	1 mg/ml	2705001S

Separating Solutions

Pancoll

Description

In many cases the isolation of cells is the first step for gene expression studies or in diagnostic procedures. Besides biological separation techniques physical separation methods are most commonly used. These methods use physical differences such as size and weight of the particles to be separated. For this purpose so-called separating solutions (= centrifugation media) are used.

Our Pancoll separating solutions contain a polysaccharide with a molecular weight of 400,000 daltons; this hydrophilic polymer allows for production of aqueous solutions for cell separation with a density of up to 1.2 g/ml. PAN-Biotech offers a variety of ready-to-use products with a density of 1.063 g/ml up to 1.091 g/ml for a very wide range of cell separation applications.

Storage: 2° C to ambient temperature „Protect from light!“

When properly stored, separating solutions are stable for at least 36 months. The storage period starts with the manufacturing date.

Pancoll human, density 1.077 g/ml ⁽¹⁾	100 ml	P04-60100
	500 ml	P04-60500
Pancoll human for Granulocytes, density 1.119 g/ml ⁽¹⁾	100 ml	P04-60110
	500 ml	P04-60150
Pancoll mouse, density 1.086 g/ml ⁽²⁾	100 ml	P04-64100
	500 ml	P04-64500
Pancoll rat, density 1.091 g/ml ⁽²⁾	100 ml	P04-65100
	500 ml	P04-65500
Pancoll animal, density 1.077 g/ml ⁽²⁾	100 ml	P04-63100
	500 ml	P04-63500
Pancoll monocytes, density 1.068 g/ml ⁽³⁾	100 ml	P04-68100
	500 ml	P04-68500
Pancoll platelets, density 1.063 g/ml ⁽³⁾	100 ml	P04-67100
	500 ml	P04-67500

- (1) usually on stock
- (2) minimum order 20 pieces
- (3) available upon request

Separating Solutions Pre-Filled

Description

Pancoll separating solutions from PAN-Biotech are made from a neutral, highly cross-linked, hydrophilic polymer of sucrose with an average molecular weight of 400,000 daltons. Pancoll is suited for separation of lymphocytes and other cell types.

The ready-to-use solutions are available in 500 ml bottles (see page 105) as well as in pre-filled ready-to-use tubes with a separating membrane.

Stability

Pancoll is stable for 36 months at 2 °C to 20 °C. Protect from light!

Typical results with Pancoll

Lymphocytes	60 ± 20 %	yield of lymphocytes from original blood samples of the lymphocyte fraction are mononuclear leukocytes live cells (trypan blue-exclusion)
	95 ± 5 %	
	> 90 %	
Other cells	3 ± 2 % 5 ± 2 % < 0,5 %	granulocytes erythrocytes total number of platelets of the original blood sample

Method of separation

For lymphocyte separation blood is used which has been defibrinated or treated with anticoagulants (Heparin, EDTA, Citrate), and which is diluted with the same volume of a physiological saline solution. Then the Pancoll solution is carefully covered with a layer of diluted blood in a centrifuge vial, without mixing the phases. After a short centrifugation step (e.g. 800-1000x g for 20-30 minutes without brake) at room temperature the lymphocytes, together with monocytes and platelets, can be harvested from the white blood cells layer between the plasma sample layer and the Pancoll. The separated cells are then washed twice in physiological saline solution to purify the lymphocytes by removing platelets. During centrifugation the cells of the blood sample migrate to the Pancoll layer where they get into contact with the polysaccharide contained in Pancoll. The red blood cells are aggregated by this substance at room temperature immediately. Aggregation causes an increase of the sedimentation rate of the red blood cells which aggregate together with the granulocytes as a sediment at the bottom of the centrifuge vial. Lymphocytes, monocytes and platelets are not so dense and can not enter and pass through the Pancoll layer. These cells are concentrated as white blood cell layer above the Pancoll layer and therefore can be harvested easily by careful pipetting. In subsequent centrifugation steps the lymphocytes are washed to remove remaining platelets, serum and Pancoll. As a result of this process a highly purified suspension of viable lymphocytes and monocytes (PBMC) is obtained.

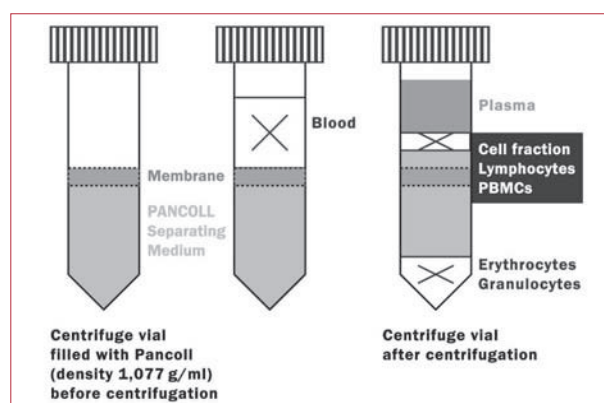

Pancoll human, density 1.077 g/ml ⁽¹⁾	25 x 50 ml	P04-60125
	50 x 10 ml	P04-60225
Pancoll animal, density 1.077 g/ml ⁽³⁾	50 x 10 ml	P04-63225

(1) usually on stock
(2) minimum order 20 pieces
(3) available upon request

Cryo Preservation

DMSO

Description

DMSO (Dimethylsulfoxide) is a colourless organic solvent which enters the cell and distributes inside the cell

to prevent the formation of damaging ice crystals during the freezing procedure.

Dimethylsulfoxide (DMSO) Bio Chemica	100 ml	P60-15840100
Dimethylsulfoxide (DMSO) for cell culture	100 ml	P60-36720100

Freezing Medium

Description

Our freezing medium is recommended for the cryo-conservation of cells. The medium is based on DMEM, supplemented with a mix of fetal bovine serum and

DMSO. This composition guarantees a high survival rate and excellent cell growth after thawing.

Freezing medium ⁽¹⁾	50 ml	P07-90050
--------------------------------	-------	-----------

Cryopan I

Description

Cryopan I is a serum-free freezing medium for the cryo-conservation of cells in a nitrogen storage tank or an ultra-low temperature freezer (< -150° C). It contains DMSO.

Freezing procedure

- Refrigerate freezing medium, culture medium and freezing tubes!
- Trypsinize cells, transfer the cells into the culture medium and centrifuge. Discard the supernatant and resuspend in culture medium
- Cell count should be adjusted to 1 - 5 x 10⁶/ml. The cells should be carefully resuspended to avoid clustering
- Spin down and resuspend the cells in an appropriate volume of cool freezing medium by pipetting only once or twice. Distribute 1 ml cell suspension per freezing tube
- To achieve a defined freezing rate of about 1° C per minute, manual freezing devices or computer-controlled freezing may be used

Ideal freezing rate: decrease of 1° C per minute

Cryopan I ⁽³⁾	10 ml	P07-92010
	50 ml	P07-92050

- (1) usually on stock
- (2) minimum order 20 pieces
- (3) available upon request

Bovine Serum Albumin

Description

Albumins serve as additive proteins for tissue cultures. They are the main protein component in serum and are added to cell culture media to increase the stability of cell membranes and to bind possibly toxic elements.

Advantages

- High purity > 99 %
- Minimal lot to lot variation
- Stringent control of raw materials
- US origin
- Full documentation
- Special products for unique applications

Storage

Powder and preserved solutions at 2 - 8 °C.
Preservative free solution at -20 °C

Bovine Serum Albumin (BSA) Fraction V ⁽¹⁾	50 g	P06-1391050
	100 g	P06-1391100
	500 g	P06-1391500
Bovine Serum Albumin (BSA) Protease free ⁽¹⁾	100 g	P06-139210
	500 g	P06-139250
Bovine Serum Albumin (BSA) Low Endotoxin ⁽¹⁾	10 g	P06-139310
	50 g	P06-139350
Bovine Serum Albumin (BSA) Fatty acid free ⁽¹⁾	10 g	P06-139410
	50 g	P06-139450
Bovine Serum Albumin (BSA) 30 % Solution, ⁽¹⁾ Low salt	100 ml	P06-138110
	500 ml	P06-138150
Bovine Serum Albumin (BSA) 30 % Solution, ⁽¹⁾ High salt	100 ml	P06-138210
	500 ml	P06-138250
Bovine Serum Albumin (BSA) 30 % Solution, ⁽¹⁾ High polymer	100 ml	P06-138310
	500 ml	P06-138350
Bovine Serum Albumin (BSA) 30 % Solution, ⁽¹⁾ Low salt, Preservative free, Protease free	100 ml	P06-138410
	500 ml	P06-138450

Other sizes and products are available upon request.

Human Serum Albumin

Description

Human Serum Albumin is a high quality product suitable for different applications.

Storage

Human Serum Albumin can be stored at 2 - 8 °C.

Human Serum Albumin (HSA) ⁽³⁾	25 g	P06-26025
	50 g	P06-26050
Human Serum Albumin (HSA) Fatty acid free ⁽³⁾	50 g	P06-26150
	100 g	P06-261100
Human Serum Albumin (HSA) 20% Solution ⁽³⁾	20 ml	P06-27020
	100 ml	P06-27100
	500 ml	P06-27500

(1) usually on stock

(2) minimum order 20 pieces

(3) available upon request

Biologicals

Introduction	129
Human Cytokines and Growth Factors	130
Others Species Cytokines and Growth Factors	133

Introduction

Cytokines, growth factors, and chemokines from PAN-Biotech

Cytokines are becoming increasingly important in cell biology. Sugar-containing proteins have regulating functions for the growth and differentiation of body cells. Many cytokines also play an important role in immunological reactions, and they are then generally referred to as mediators.

Cytokines, which primarily trigger and/or regulate the proliferation and differentiation of target cells, are known as growth factors. These proteins that are transferred as signals from one cell to another, and therefore relay information, play a role mainly in the development of multi-cellular organisms. Growth factors are either secreted i.e. released by the cells into the environment or they are membrane-bound. They function when recognised by a receptor on the surface of the target cell. Only cells that carry the specific receptor for the respective growth factor (= ligand) can respond to the signal.

As soon as the factor binds to its ligand, a change in conformation results in the generation of an intracellular signal. By further signal transfer, this will cause genes to be activated or inactivated.

PAN-Biotech offers a high-quality range of cytokines, growth factors as well as chemokines, chemotactical cytokines ("chemoattractant cytokines"), which can be secreted by many cell types e.g. from phagocytes and dendritic cells but also from tissue cells.

Chemokines can attract and activate leukocytes. They therefore play an important role as mediators in regulating targeted leukocyte migration and the inflammation processes triggered as a result.

Please ask for any chemokine or growth factor which is not listed. We may be able to supply.

Human Cytokines and Growth Factors

Short Term	Description	Cat.no.	Size
Acrp30 HEK	Adiponectin Globular rec.	CB-2800007 CB-2800008	2 µg 10 µg
Acrp30	Adiponectin rec.	CB-2800001 CB-2800002	5 µg 25 µg
Acrp30 Tri	Adiponectin Trimeric Form rec.	CB-2800010 CB-2800011	2 µg 10 µg
BMP-4	Bone Morphogenetic protein-4 rec.	P-3610002	2 µg
BMP-6	Bone Morphogenetic protein-6 rec.	CB-1113008	2 µg
BMP-7	Bone Morphogenetic protein-7 rec.	CB-1113011 CB-1113012	2 µg 10 µg
BDNF	Brain-Derived Neurotrophic Factor rec.	CB-1115000 CB-1115001 CB-1115002	2 µg 10 µg 1 mg
CT-1	Cardiotrophin-1 rec.	CB-1115006	2 µg
CNTF	Ciliary Neurotrophic Factor rec.	CB-1515001	20 µg
EGF	Epidermal Growth Factor rec.	CB-1101001 CB-1101002 CB-1101003	100 µg 500 µg 1 mg
EPO-α	Erythropoietin-alpha rec.	CB-2015001	50 µg
FGF-1	Fibroblast Growth Factor-acidic rec.	CB-1102010 CB-1102011	10 µg 50 µg
FGF-2	Fibroblast Growth Factor-basic rec.	CB-1102024 CB-1102021 CB-1102023	10 µg 50 µg 1 mg
Flt3	Flt3-Ligand rec.	CB-1119000 CB-1119001	2 µg 10 µg
GDNF	Glial-Driven Neurotrophic Factor rec.	CB-1116001	10 µg
GMCSF/IL3	gm-csf/IL-3 Fusion Protein (PIXY321) rec.	CB-2110005	10 µg
GMCSF	Granulocyte Macrophage-Colony Stimulating Factor rec.	CB-2110000 CB-2110003	2 µg 1 mg
GCSF	Granulocyte-Colony Stimulating Factor rec.	CB-2110100 CB-2110101	2 µg 10 µg
HGF Sf9	Hepatocyte Growth Factor Sf9 rec.	CB-1108002 CB-1108010 CB-1108100	2 µg 10 µg 1 mg
HGF CHO	Hepatocyte Growth Factor, CHO, rec.	CB-1108003 CB-1108011	2 µg 10 µg
IGF-1	Insulin Like Growth Factor-1 rec.	CB-1104113	100 µg
IGF-2	Insulin Like Growth Factor-2 rec.	CB-1104201 CB-1104202	10 µg 50 µg
Insulin	Insulin human rec.	P-2701002 P-2701001	25 mg 250 mg

Human Cytokines and Growth Factors

Short Term	Description	Cat.no.	Size
IFN- α 1	Interferon-alpha 1 rec.	CB-2120100	2 μ g
		CB-2120101	10 μ g
IFN- α 2a	Interferon-alpha 2a rec.	CB-2120110	20 μ g
		CB-2120112	100 μ g
IFN- β 1a	Interferon-beta 1a rec.	P-2360011	2 μ g
		P-2360012	10 μ g
		P-2360013	1 mg
IFN- β 1b	Interferon-beta 1b rec.	CB-2120121	10 μ g
IFN- γ	Interferon-gamma rec.	P-2060020	20 μ g
		P-2060100	100 μ g
IL-1 β	Interleukin-1 beta rec.	CB-2130120	2 μ g
		CB-2130121	10 μ g
IL-1 β His	Interleukin-1 beta, His Tag rec.	CB-2130123	5 μ g
IL-10	Interleukin-10 rec.	CB-2131000	2 μ g
		CB-2131001	10 μ g
IL-12	Interleukin-12 rec.	CB-2131201	10 μ g
IL-15	Interleukin-15 rec.	CB-2131500	2 μ g
		CB-2131501	10 μ g
IL-2	Interleukin-2 rec.	CB-2130203	10 μ g
		CB-2130202	50 μ g
IL-3	Interleukin-3 rec.	CB-2130300	2 μ g
		CB-2130301	10 μ g
IL-4	Interleukin-4 rec.	CB-2130405	2 μ g
		CB-2130407	10 μ g
IL-5	Interleukin-5 rec.	CB-2130501	10 μ g
IL-6	Interleukin-6 rec.	CB-2130600	5 μ g
		CB-2130603	20 μ g
KGF	Keratinocyte Growth Factor rec.	CB-1105001	10 μ g
Leptin	Leptin rec.	CB-1300058	200 μ g
LIF	Lif rec.	CB-1106001	10 μ g
β -NGF	Nerve Growth Factor beta 2 rec.	CB-1117001M	5 μ g
		CB-1117001	20 μ g
NRG1	Neuregulin-1/Heregulin-b2 rec.	CB-4070010	10 μ g
NT-3	Neurotrophin-3 rec.	CB-1125032	10 μ g

Human Cytokines and Growth Factors

Short Term	Description	Cat.no.	Size
PDGF-AA	Platelet Derived Growth Factor-AA rec.	CB-3410010	10 µg
		CB-3410011	1 mg
PDGF-AB	Platelet Derived Growth Factor-AB rec.	CB-1109301	10 µg
PDGF-BB	Platelet Derived Growth Factor-BB rec.	CB-1109200	2 µg
		CB-1109201	10 µg
Resistin	Resistin rec.	CB-1300118	5 µg
SCF	Stem Cell Factor rec.	CB-1110000	2 µg
		CB-1110001	10 µg
		CB-1110002	1 mg
TPO	Thrombopoietin rec.	CB-1127000	2 µg
TRAIL	TNF-Related Apoptosis Inducing Ligand/Apo2L rec.	CB-1127100	10 µg
TGF-β 1	Transforming Growth Factor-Beta 1 rec.	CB-1111131	1 µg
		CB-1111122	5 µg
TGF-β 3	Transforming Growth Factor-Beta 3 rec.	CB-1111151	2 µg
		CB-1111153	10 µg
rHuTNFR	Tumor Necrosis Factor Receptor Fusion Protein rec.	CB-1111162	1 mg
TNF-α	Tumor Necrosis Factor-alpha rec.	CB-1112011	10 µg
		CB-1112012	50 µg
VEGF (121)	Vascular Endothelial Growth Factor (121) rec.	CB-1114002	10 µg
VEGF	Vascular Endothelial Growth Factor rec.	CB-1114100	2 µg
		CB-1114102	10 µg
VEGF-C	Vascular Endothelial Growth Factor Related Protein rec.	CB-1114011	10 µg
VEGF CHO	Vascular Endothelial Growth Factor, CHO rec.	CB-1114013	2 µg

Other Species Cytokines and Growth Factors

Short Term	Description	Cat.no.	Size
mβ-NGF	Murine beta Nerve Growth Factor rec.	CB-1117007 CB-1117008	5 µg 20 µg
mEGF	Murine Epidermal Growth Factor rec.	CB-1214120 CB-1214121	100 µg 500 µg
mFGF-2	Murine Fibroblast Growth Factor-basic rec.	P-3860001 P-3860002	10 µg 50 µg
mFlt3	Murine Flt3-Ligand rec.	CB-2250001	10 µg
mGMCSF	Murine Granulocyte Macrophage-Colony Stimulating Factor rec.	CB-2210000 CB-2210001 CB-2210002	2 µg 10 µg 1 mg
mIFN-γ	Murine Interferon-gamma rec.	CB-2230030 CB-2230031	20 µg 100 µg
mIL-1α	Murine Interleukin-1 alpha rec.	CB-2230111	10 µg
mIL-1β	Murine Interleukin-1 beta rec.	CB-2230120 CB-2230121	2 µg 10 µg
mIL-12	Murine Interleukin-12 rec.	CB-2231202	0.1 mg
mIL-2	Murine Interleukin-2 rec.	CB-2230220 CB-2230221	5 µg 20 µg
mIL-3	Murine Interleukin3- rec.	CB-2230300 CB-2230301 CB-2230302	2 µg 10 µg 1 mg
mIL-4	Murine Interleukin-4 rec.	CB-2230403	2 µg
mIL-6	Murine Interleukin-6 rec.	CB-2230600 CB-2230601 CB-2230602	2 µg 10 µg 1 mg
mMCSF	Murine Macrophage Colony Stimulating Factor rec.	P-4390002 P-4390010	2 µg 10 µg
mSCF	Murine Stem Cell Factor rec.	CB-1210000	2 µg
mTNF-α	Murine Tumor Necrosis Factor-alpha rec.	CB-1212011M CB-1212011	5 µg 20 µg
mVEGF	Murine Vascular Endothelial Growth Factor rec.	CB-1214000 CB-1214001	2 µg 10 µg
bECGS	ECGS (from bovine hypothalamus)	CB-11000050	50 mg
oPrl	Ovine Prolactin rec.	CB-2310015 CB-2310016	10 µg 50 µg
rIFN-γ	Rat Interferon-gamma rec.	CB-2420031 CB-2420032	20 µg 100 µg
rTNF-α	Rat Tumor Necrosis Factor-alpha rec.	CB-1412011	20 µg

Molecular Biology

Introduction	135
Taq DNA Polymerase	136
PANScript DNA Polymerase	137
PANScript red DNA Polymerase	138
PAN Hot Start DNA Polymerase	139
PowerScript DNA Polymerase short range	140
PowerScript DNA Polymerase long range	141
Proteinase K	142
PAN Ladder I	142
PAN DNA Clean	143
Agarose (molecular grade)	144
dNTP Sets	145
dNTP Mix	146
Transfection Reagents / PANfect	147

Introduction

Background of Molecular Biology

The field of molecular biology overlaps with biology and chemistry and in particular, genetics and biochemistry. Molecular biology looks at the molecular mechanisms behind processes such as replication, transcription, translation and cell function. One way to describe the basis of molecular biology is to say it concerns understanding how genes are transcribed into RNA and how RNA is then translated into protein.

PAN-Biotech offers a wide selection of products for molecular biology applications such as products suitable for TA cloning, products that are ideal for problematic templates that fail with standard Taq DNA Polymerases, RNA analysis, DNA sequencing and others.

The polymerase chain reaction (PCR) is a scientific technique in molecular biology to amplify a single or a few copies of a piece of DNA (in vitro) across several orders of magnitude, generating thousands to millions of copies of a particular DNA sequence. There are three major steps involved in the PCR technique: DNA-denaturation, primer annealing, and extension.

PCR is now a common and often indispensable technique, which is used in biological, medical and forensics laboratories for a huge number of different duties, for example, for the identification of hereditary diseases, infections and DNA analytics (genetic fingerprint, parental testing, phylogenetic tree). Nowadays PCR counts to the most important methods of the modern molecular biology.

PAN-Biotech offers different, specialized DNA Polymerases, Desoxy-Nucleotides, Polymerase-buffer solution, DNA Clean and various DNA-Markers.

Polymerases

Taq DNA Polymerase

A Taq DNA Polymerase is a thermostable DNA polymerase which transcribes exactly the template DNA. The Taq DNA Polymerase is optimized for a high selectivity during the amplification. The high processivity of Taq polymerase allows the amplification of DNA fragments up to 10kBasen.

We recommend the Taq Polymerase for the range of **100bp to 8.000bp**.

In addition, the Taq polymerase is suitable for DNA labeling with dUTP.

Storage and dilution buffer

20 mM Tris-HCl (pH 8.0), 100 mM KCl, 0.1 mM EDTA, 1 mM DTT, 50% glycerol, 0.5% Nonidet P40 and 0.5% Tween 20.

Unit definition

One unit is defined as the amount of enzyme that incorporates 10 nmoles of dNTP's into acid-insoluble form in 30 minutes at 72° C under the assay conditions: 25 mM TAPS (tris-(hydroxymethyl)-methyl-amino-propansulfonic acid, sodium salt) pH 9,3 (at 25° C), 50 mM KCl, 2 mM MgCl₂, 1 mM beta-mercaptoethanol, and activated calf thymus DNA as substrate.

Supplied buffers (alternatively with complete or incomplete buffer)

- 10x PCR buffer with MgCl₂:
100 mM Tris-HCl (pH 9.0 at 25° C), 500 mM KCl
15 mM MgCl₂, 1.0% Triton X-100
- 10x PCR buffer without MgCl₂:
100 mM Tris-HCl (pH 9.0 at 25° C), 500 mM KCl
1.0% Triton X-100
- Magnesium stock solution:
25 mM MgCl₂

Stability

The enzyme is stable for more than 12 months if stored at -20° C. The enzyme is also stable for some days at temperatures above 20° C.

Taq-Polymerase can also be stored at 2-8°C up to 3 months.

Associated activities

Endonuclease and exonuclease activities were not detectable under the standard assay conditions

1. Incubation of 1µg PUC19 Vektor-DNA with 10 units Taq-Polymerase for 16 hours at 37°C.
2. Incubation of 1µg deoxyoligonukleotid (20 mer) with 50 units of enzymes for 6 hours at 37°C.

Properties and application

The Taq DNA Polymerase is a thermostable DNA polymerase from *Thermus aquaticus* of high purity with good fidelity and high processivity.

Taq DNA Polymerase with buffer and MgCl ₂	250 units	MB-30010250
Taq DNA Polymerase with buffer and MgCl ₂ with Phenol red	250 units	MB-30020250

Polymerases

PANScript DNA Polymerase**Features and applications**

- Consistent results
- Premium Taq polymerase suited for a wide range of applications
- Processes fragments of up to 5Kb
- Leaves "A" overhang
- Available as ready-to-use 2x reaction mixes (PAN Mix and PAN Mix red)
- Routine PCR applications
- Products suitable for TA cloning

PANScript is widely used by molecular biologists that have come to depend upon the robust performance of this reagent.

PANScript is a highly purified thermostable DNA polymerase offering very high yield over a wide range of PCR templates, and is the ideal choice for most assays. PANScript is a robust preparation and consistently delivers high yields with minimal background. PANScript possesses 5' to 3' exonuclease activity and leaves an "A" overhang such that the PCR product is suitable for effective integration into TA cloning vectors.

PANScript is supplied with 10x NH₄-based reaction buffer, which provides optimal conditions for most experiments. Additional MgCl₂ is provided to allow reaction conditions to be adjusted to suit the template. The specificity and performance of PANScript can be further improved with the use of 2x PAN Mate Additive (Cat No. PAN737041), which is designed for GC- or AT-rich DNA, dirty templates or sequences with a high level of secondary structure.

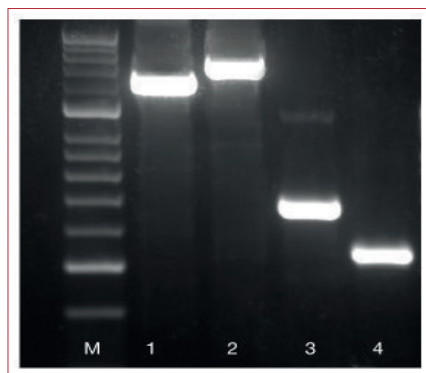

High performance with PANScript
Amplification of a variety of fragments

Four different genes were amplified from mouse genomic DNA using PANScript DNA Polymerase: 1.4kb and 1.6kb fragment of rna 18s gene (lanes 1 and 2), 500bp fragment of Fabpi gene (lane 3), 350bp fragment of IL-2 gene (lane 4). HyperLadder 50bp (M).

PANScript DNA Polymerase is purified from *Thermus aquaticus*.

PCR Reaction Conditions (for a 50 µl volume)

10x NH ₄ Buffer	5 µl
50 mM MgCl ₂ Solution	1.5 - 4.0 µl
100 mM dNTP Mix (see below)	0.5 - 1.0 µl
Template and Primers	as required
PANScript	0.5 - 1.0 µl
Water (ddH ₂ O)	up to 50 µl
100 mM dNTP Mix is available as a separate product (Cat No: PAN739028)	

The optimum concentration of Mg²⁺ is 3mM and should only be increased above this if absolutely necessary.

Denature: 94 – 96° C

Elongate: 70 – 72° C (allowing 15 - 30 seconds/Kb)

This data is intended for use as a guide only; conditions will vary from reaction to reaction and may need optimization.

Reagent specifications

10x NH₄ Reaction Buffer:

160 mM (NH₄)₂SO₄, 670mM Tris-HCl (pH 8.8 at 25° C), 0.1% stabilizer

MgCl₂ Stock Solution:

50 mM MgCl₂ (suggested final concentration 1.5 mM - 4 mM).

Storage buffer

20 mM Tris-HCl, pH 7.5, 100 mM NaCl, 0.1 mM EDTA, 2 mM DTT, 50% Glycerol and stabilizers.

Storage conditions

PANScript can be stored for 12 months at -20° C.

Associated activities

Endonuclease and exonuclease activities were not detectable after 2 and 1 hour incubations, respectively, of 1 µg lambda DNA and 0.22 µg of EcoR I-digested lambda DNA at 72° C in the presence of 15 - 20 units of PANScript DNA polymerase.

Unit definition

One unit will incorporate 10nmoles of dNTPs in 30 minutes at 72° C.

PANScript DNA Polymerase	500 units	MB-1100500
--------------------------	-----------	------------

Polymerases

PANScript red DNA Polymerase**Features and applications**

- Easy visual recognition
- Direct loading onto agarose gels
- Same high performance as PANScript DNA Polymerase
- Leaves "A" overhang
- Available as a ready-to-use 2x reaction mix (PAN Mix Red)
- Routine PCR assays
- Products suitable for TA cloning
- High throughput applications

PANScript red DNA Polymerase is a formulation of our regular PANScript DNA Polymerase, which contains a non-toxic and non-hazardous red dye. The red dye provides an easy and quick identification of reactions to which the enzyme has been added, and facilitates the confirmation of complete mixing. When the reaction is complete, a sample of the reaction mix can be loaded directly onto the agarose gel without the need for loading buffer, since the mix is of sufficiently high density to sink to the bottom of the gel. The red dye migrates towards the positive electrode, thereby providing a means to monitor the progress of the electrophoresis.

The presence of the dye has no effect on routine enzymatic manipulations, although rare exceptions may occur. In order to produce a reaction of sufficient density to allow for the direct loading of a sample onto a gel, we recommend using a minimum of 1.5 Units per 50 µl reaction.

The specificity and performance of PANScript red can be further improved with the use of 2x PAN Mate Additive (Cat No. PAN737041), which is designed for GC or AT-rich DNA, dirty templates or sequences with a high level of secondary structure.

PANScript DNA Polymerase is purified from *Thermus aquaticus*.

PCR Reaction Conditions (for a 50 µl volume)

10x NH ₄ Buffer	5 µl
50 mM MgCl ₂ Solution	1.5 - 4.0 µl
100 mM dNTP Mix (see below)	0.5 - 1.0 µl
Template and Primers	as required
PANScript red	1.5 - 2.5 µl
Water (ddH ₂ O)	up to 50 µl

100 mM dNTP Mix is available as a separate product (Cat No: PAN739026)

Denature: 94° - 96° C

Elongate: 70° - 72° C (allowing 15 - 30 seconds/Kb)

This data is intended for use as a guide only; conditions will vary from reaction to reaction and may need optimization.

Reagent specifications

10x NH₄ Reaction Buffer: 160 mM (NH₄)₂SO₄, 670 mM Tris-HCl (pH 8.8 at 25° C), 0.1% stabilizer
MgCl₂ Stock Solution: 50 mM MgCl₂ (suggested final concentration 1.5 mM - 4 mM).

Storage buffer

20 mM Tris-HCl, pH 7.5, 100 mM NaCl, 0.1 mM EDTA, 2 mM DTT, 50% Glycerol and stabilizers and inert dye.
Storage Conditions

PANScript red can be stored for 12 months at -20° C.

Associated activities

Endonuclease and exonuclease activities were not detectable after 2 and 1 hour incubations, respectively, of 1 µg lambda DNA and 0.22 µg of EcoR I-digested lambda DNA at 72° in the presence of 15 - 20 units of PANScript red DNA polymerase.

Unit definition

One unit is defined as the amount of enzyme that incorporates 10 nmoles of dNTPs into acid-insoluble form in 30 minutes at 72° C.

PANScript red DNA Polymerase	500 units	MB-1100600
------------------------------	-----------	------------

Polymerases

PAN Hot Start DNA Polymerase

Features and applications

- Outstanding and robust performance
- For PCR assays requiring hot-start
- Excellent yield in quantitative assays
- Convenient set up at room temperature
- Leaves "A" overhang
- Available as ready-to-go versions PAN Hot Mix and PAN Hot Mix red
- Highly suited to real-time assays
- Products suitable for TA cloning

PAN Hot Start is a heat-activated thermostable DNA polymerase isolated from a novel organism. PAN Hot Start provides improved specificity as compared to standard polymerases and can eliminate the presence of non-specifics, such as primer-dimers and mis-primed products. PAN Hot Start is inactive at room temperature and therefore, prior to PCR cycling, requires activation by heat treatment for 10 minutes. Subsequently, the reaction can be handled according to the user's existing protocols for thermostable DNA polymerases.

Specificity and performance of PAN Hot Start can be further improved with the use of 2x PAN Mate Additive, which is designed for GC- or AT-rich DNA, „dirty“ templates or sequences with a high level of secondary structure.

PCR Reaction Conditions (for a 50 µl volume)

10x PAN Hot Start Buffer	5 µl
50 mM MgCl ₂	1.5 - 4.0 µl
100 mM dNTP Mix (see below)	0.5 - 1.0 µl
Template and Primers	as required
PAN Hot Start	0.2 - 1.0 µl
Water (ddH ₂ O)	up to 50 µl

100 mM dNTP Mix is available as a separate product (Cat No: PAN739028)

Activate: pre-heating step at 95° C for 10 minutes

Denature: 94° - 96° C

Extension: 72° C (allowing 15 - 30 seconds/Kb)

This data is intended for use as a guide only; conditions will vary from reaction to reaction and may need optimization.

Reagent specifications

10x PAN Hot Start Buffer: 160mM (NH₄)₂SO₄, 1M Tris-HCl pH 8.3 and enhancers

Storage Conditions

PAN Hot Start DNA Polymerase can be stored for 12 months at -20° C.

Storage and Dilution Buffer

20 mM Tris-HCl, pH 7.5, 100 mM NaCl, 0.1mM EDTA, 2 mM DTT, 50% Glycerol, and stabilizers.

Associated activities

Endonuclease and exonuclease activities were not detectable after 4 hours of incubation of 1 µg of pBR322 plasmid DNA and 0.5 µg Hind III-digested lambda phage DNA at 72° C in the presence of 20 u of PAN Hot Start.

Unit definition

One unit is defined as the amount of enzyme that incorporates

10nmoles of dNTPs into acid-insoluble form in 30 minutes at 72° C.

Activation Profile of PAN Hot Start DNA Polymerase

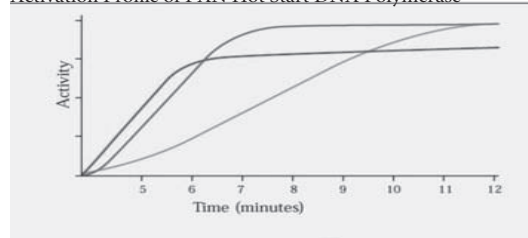

— 97°C
— 95°C
— 93°C

Activation is most effective at 95°C for 7-10 minutes.

Activation of PAN Hot Start compared to PAN Script DNA Polymerase

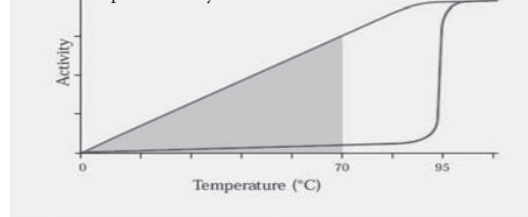

— PAN Hot start DNA Polymerase
— PAN Script DNA Polymerase
■ Wrongly annealed primers could be extended in this temperature range

Initial stages of reaction, showing PAN Script active and extending wrongly annealed primers and PAN Hot start still inactive

PAN Hot Start DNA Polymerase

250 units
500 units
5000 units

MB-1860250
MB-1860500
MB-1865000

Polymerases

PowerScript DNA Polymerase short range**Features and applications**

- Ideal for problematic templates that fail with standard Taq DNA Polymerases
- Amplifies genomic fragments up to 3 kb
- Higher fidelity than Taq
- For high fidelity PCR
- Suitable for both TA and blunt-end cloning

PowerScript short DNA Polymerase is a high-performance proprietary complex of enzymes specifically designed for difficult/problematic PCR applications requiring high processivity with fidelity that would normally fail with standard Taq Polymerases.

PowerScript short DNA Polymerase is recommended for short genomic DNA fragments of up to 3 Kb, or up to 5 Kb on Lambda DNA.

Components	250 Units	500 Units
PowerScript short range	62.5 µl	125 µl
10x OptiBuffer	1.2 ml	2 x 1.2 ml
50 mM MgCl ₂ Solution	1.2 ml	1.2 ml
5x Hi-Spec Additive	1.2 ml	1.2 ml

Reagent specifications

5x Hi-Spec Additive is a specificity enhancer. If necessary, re-dissolve Hi-Spec by heating to 70° C and vortexing.

Storage buffer

20 mM Tris-HCl, pH 7.5, 100 mM NaCl, 0.1mM EDTA, 2 mM DTT, 50% Glycerol, and stabilizers.

Storage conditions

PowerScript short DNA Polymerase can be stored for 12 months at -20° C.

Associated activities

Endonuclease and exonuclease activities were not detectable after 4 hours of incubation of 1 µg of pBR322 plasmid DNA and 0.5 µg Hind III-digested Lambda DNA at 72° C in the presence of 20 units of PowerScript short.

Unit definition

One unit is defined as the amount that incorporates 10nmoles of dNTPs into acid-precipitable form in 30 minutes at 72° C.

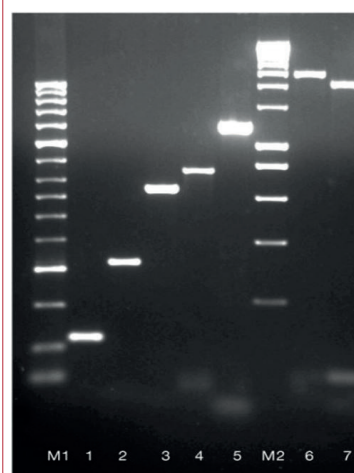
**High specificity with problematic templates using PowerScript short.**

A range of fragments from human genes were amplified, varying in length and GC content.

- M1: PANLadder II
 Lane 1: 119 bp and 43% GC product amplified from the human glucocerebrosidase gene
 Lane 2: 321 bp and 37% GC product amplified from Angiotensin receptor II gene
 Lane 3: 626 bp and 56% GC product amplified from the Rhodopsin gene
 Lane 4: 762 bp and 33% GC product amplified from the β-Globin gene
 Lane 5: 1200 bp and 54% GC product amplified from the alpha-1-antitrypsin gene
 M2: PANLadder I
 Lane 6: 2256 bp and 52% GC product amplified from the p53 gene
 Lane 7: 2000 bp and 32% GC product amplified from the Angiotensin receptor II gene

PowerScript DNA-Polymerase short range	250 units	PAN721064
	500 units	PAN721065

Polymerases

PowerScript DNA Polymerase long range**Features and applications**

- Ideal for problematic templates that fail with standard Taq DNA Polymerases
- Ideal for fragments 2 - 20 Kb in length
- Higher fidelity with Taq Polymerases
- Available as a ready-to-use 2x reaction mix
- For high fidelity PCR
- Suitable for both TA and blunt-end cloning

PowerScript DNA Polymerase long range is a high-performance proprietary complex of enzymes specifically designed for difficult/problematic PCR applications requiring high processivity with fidelity that would normally fail with standard Taq polymerases.

PowerScript DNA Polymerase long range is recommended for long genomic DNA fragments of between 2 - 20 Kb, or up to 30 Kb Lambda DNA fragments. With Lambda DNA as template, the best performance is achieved in the 2 - 20 Kb range. PowerScript long is our original widely used PowerScript formulation.

Components	250 Units	500 Units
PowerScript long range	62.5 μ l	125 μ l
10x OptiBuffer	1.2 ml	2 x 1.2 ml
50 mM MgCl ₂ Solution	1.2 ml	1.2 ml
5x Hi-Spec Additive	1.2 ml	1.2 ml

Reagent specifications

5x Hi-Spec Additive is a specificity enhancer. If necessary, re-dissolve Hi-Spec by heating to 70° C and vortexing.

Storage buffer

20 mM Tris-HCl, pH 7.5, 100mM NaCl, 0.1mM EDTA, 2 mM DTT, 50% Glycerol, and stabilizers.

Storage conditions

PowerScript long DNA Polymerase can be stored for 12 months at -20° C.

Associated activities

Endonuclease and exonuclease activities were not detectable after 4 hours of incubation of 1 μ g of pBR322 plasmid DNA and 0.5 μ g Hind III-digested Lambda DNA at 72° C in the Presence of 20 units of PowerScript long.

Unit definition

One unit is defined as the amount that incorporates 10nmoles of dNTPs into acid-precipitable form in 30 minutes at 72° C.

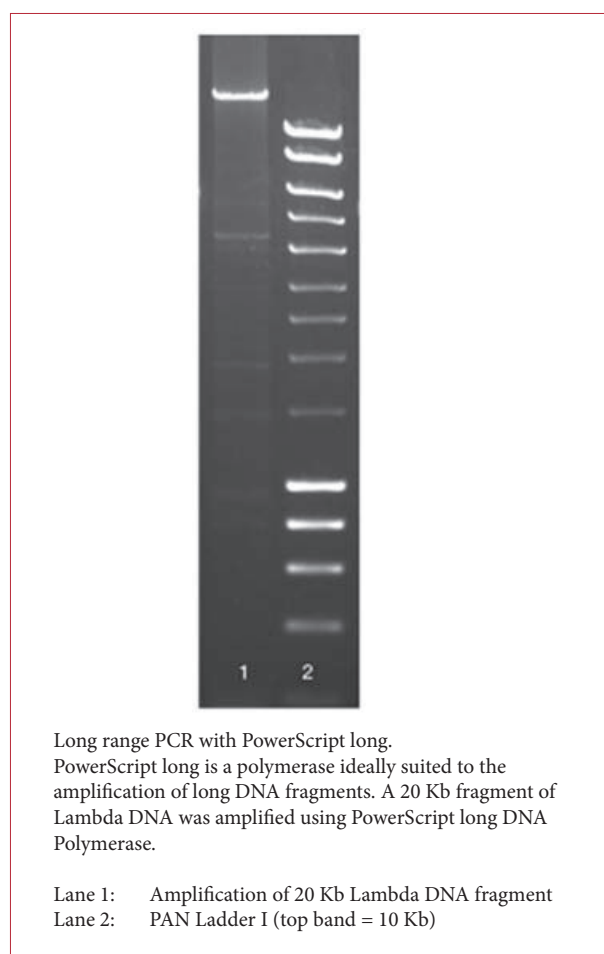

PowerScript DNA Polymerase long range	250 units	MB-1120250
	500 units	MB-1120500

Molecular Biology Reagents

Proteinase K

Features and applications

- Broad-spectrum serine protease
- Active under denaturing conditions
- Stable at high temperatures
- Molecular biology grade
- Available as powder and stabilized stock solution
- Inactivation of RNases/DNases during nucleic acid extraction
- Protein modification
- General protein digestion
- Determination of enzyme localization

Proteinase K is an enzyme used to digest most proteins in molecular-biological techniques. The enzyme may be used at 56° C for up to 4 hours, or 37° C for overnight incubations. Proteinase K solution is stabilized with a specially formulated buffer, and can be used directly from the freezer.

Recommendations for use

- Dissolve to 20 mg/ml in 50 mM Tris-HCl, 2 mM calcium acetate, pH 8.0
- Proteinase K may be used at 56° C for up to 4 hours, or 37° C for overnight incubations
- Proteinase K has an optimal pH of 7.5 - 12.0
- To remove common contaminants from nucleic acid preparations use at a working concentration of 5 µg/ml

Storage conditions

Proteinase K can be stored for 12 months at -20° C.

Contaminants

RNase Activity: No detectable ribonuclease activity detected with MS2RNA after 6 hour incubation at 37° C

DNase Activity: No detectable nicking activity detected with pBR322 after 6 hour incubation at 37° C

Unit definition

One unit is defined as the amount of enzyme that will liberate 1.0 µmol of tyrosine per minute at 37° C, pH 7.5.

Proteinase K	100 mg	MB-4300002
	500 mg	MB-4300004

PAN Ladder I

Features

- 14 bands from 200 bp - 10 000 bp
- Accurate quantitation
- Easy identification and orientation
- Ready-to-use format

PAN Ladder™ I is a popular ready-to-use molecular weight marker, especially designed for easy DNA quantification and size determination. This ready-to-use format reduces handling steps and saves time; simply transfer HyperLadder I from the vial to the gel.

PAN Ladder™ I produces a pattern of 14 regularly spaced bands, ranging from 200 to 10,000 bp. To allow easy identification and orientation, the 1000 and 10,000bp bands have the highest intensity.

When the standard loading volume of 5 µl per lane (720 ng of DNA) is being used, each band corresponds to a precise amount of DNA.

A 5x sample loading buffer is supplied for your convenience. Under no circumstances should it be used to dilute/ load ladder.

Storage conditions

PAN Ladder™ I can be stored at -20° C until first use and thereafter at 2 – 8° C for up to 6 months. Avoid multiple freeze/thaw cycles.

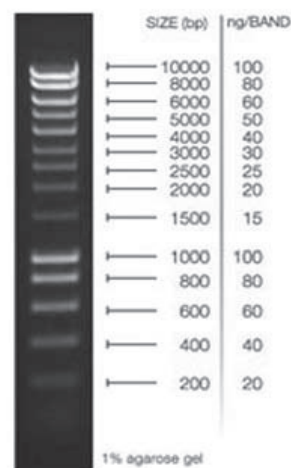

PAN Ladder I	200 lanes	PAN733025
	500 lanes	PAN733026

Molecular Biology Reagents

PAN DNA Clean

Features and applications

- Column-free PCR clean-up
- Post-PCR recovery of up to 98%
- Cost-effective, simple and rapid protocol
- Products are suitable for immediate downstream applications
- PCR clean-up
- Removes primers, primer-dimers, dNTPs and restriction enzymes
- DNA or dsRNA purification or concentration

PAN DNA Clean is a novel, inexpensive solution, which provides a column-free method for nucleic-acid purification. Using a simple and rapid procedure, PAN DNA Clean can be used to purify or concentrate DNA or dsRNA from PCR reactions or any enzymatic digests. This method is easy to follow, combining convenience, speed and excellent recovery rates.

Simple, flexible and column-free protocol

PAN DNA Clean removes proteins (such as restriction enzymes, polymerases, etc.), primers, primer-dimers and dNTPs. A very straightforward protocol allows the precipitation of nucleic acids ≥ 75 bp without the need for organic solvents, glass milk or expensive spin-columns. Unlike many column-based methods, PAN DNA Clean maximizes recovery with nucleic acid solutions, whether of low, medium or high concentration. PAN DNA Clean purifies nucleic acid without the use of chaotropic salts (which often contribute to denaturation of the DNA duplex). PAN DNA Clean enables the researcher to re-suspend the cleaned-up nucleic acids in any buffer and volume of choice, thus permitting the purification process to be tailored specifically to suit the experiment.

Optimized nucleic acid recovery

PAN DNA Clean has been tailored to maximize the amount of nucleic acid recovered after purification, providing up to 98% recovery of the original sample for immediate downstream applications, such as cloning and sequencing. PAN DNA Clean exhibits great versatility, achieving unsurpassed recovery rates, independently of the amount of nucleic acid or its concentration.

Storage conditions

PAN DNA Clean solution can be stored at room temperature for 12 months. Do not freeze. Avoid exposure to light.

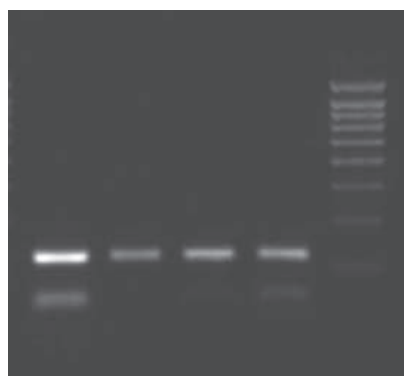

Lane 1: PCR mix before cleaning, 125 bp fragment
 Lane 2: PCR mix treated with PAN DNA Clean 1:1
 Lane 3: PCR mix treated with PAN DNA Clean 1:2
 Lane 4: Purification with PCR Clean up Kit (Silica membrane)
 Lane 5: PANLadder I

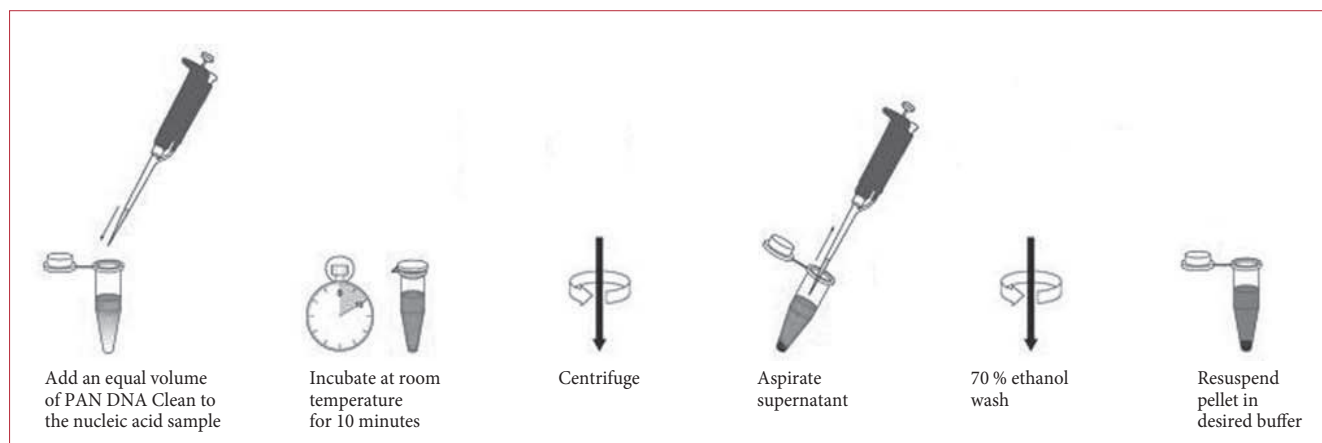

PAN DNA Clean	1 x 5 ml 2 x 12.5 ml	PAN737042 PAN737046
---------------	-------------------------	------------------------

Molecular Biology Reagents

Agarose (molecular grade)

Features

- DNase/RNase-free
- Excellent value and clarity
- High gel strength
- DNA/RNA electrophoresis
- Ideal for separating nucleic acids of a wide range of sizes, especially large fragments (> 10 Kb)

Agarose (DNase/RNase-free) is an extremely pure, high molecular biology grade agarose powder that has been extensively tested for RNase contamination. Agarose provides high resolution of DNA and RNA separated by electrophoresis and offers consistent resolution from lot to lot.

Storage conditions

Cool, dry place

Analytical specifications

Appearance:	White crystals or powder
Gel strength of 1.5% (w/v) gel:	> 1220g/cm ²
Fusion point:	88 - 90° C
Gelling temperature:	37 - 39° C
EEO:	0.05 - 0.1
Moisture:	< 7%
Sulfate:	< 0.06%
DNase and RNase:	Absent

Agarose (molecular grade)	500 g	PAN741025
---------------------------	-------	-----------

Molecular Biology Reagents

dNTP Sets

Features and applications

- Ultra-pure: > 99% tris-phosphate by HPLC
- Extended shelf-life of 24 months at -20° C
- Free from PCR inhibitors
- DNase, RNase and Nickase free

Suitable for a wide variety of applications such as:

- Standard and long range PCR assays
- cDNA synthesis
- qPCR
- Microarrays
- DNA sequencing
- DHPLC
- Labelling

A set of ready-to-use molecular grade dNTP solutions consisting of 4 separate 100mM solutions of dATP, dGTP, dCTP and dTTP. For use in DNA polymerization reactions, DNA labelling and sequencing processes. Dependable PCR grade. All dNTPs are supplied as Lithium salts in purified water at pH 7.5. Lithium salts have greater resistance to repeated freezing and thawing cycles than Sodium salts, and Lithium salt dNTP preparations remain sterile over the entire shelf life due to the bacterio-static activity of Lithium towards various microorganisms.

Storage conditions

dNTP Set can be stored for 24 months at -20° C. Avoid multiple freeze/thaw cycles. For long-term storage, aliquoting is recommended.

Characteristics	dATP	dCTP	dGTP	dTTP
Product	dATP Lithium 100 mM Solution	dCTP Lithium 100 mM Solution	dGTP Lithium 100 mM Solution	dTTP Lithium 100 mM Solution
Nomenclature	2'-deoxyadenosine- 5'-triphosphate	2'-deoxyadenosine- 5'-triphosphate	2'-deoxyadenosine- 5'-triphosphate	2'-deoxyadenosine- 5'-triphosphate
Formula	C ₁₀ H ₁₂ N ₅ O ₁₂ P ₃ Li ₄	C ₉ H ₁₂ N ₃ O ₁₃ P ₃ Li ₄	C ₁₀ H ₁₂ N ₅ O ₁₃ P ₃ Li ₄	C ₁₀ H ₁₃ N ₂ O ₁₄ P ₃ Li ₄
Molecular Weight	514.9 g/mol	490.9 g/mol	530.9 g/mol	505.9 g/mol
λ_{max} pH 7.0	259 nm	272 nm	252 nm	267 nm
ε at λ_{max} @ pH7.0	15.4 E x mmol ⁻¹ x cm ⁻¹	9.1 E x mmol ⁻¹ x cm ⁻¹	13.7 E x mmol ⁻¹ x cm ⁻¹	9.6 E x mmol ⁻¹ x cm ⁻¹
A₂₅₀ / A₂₆₀	0.78 ± 0.03	0.82 ± 0.03	1.16 ± 0.05	0.65 ± 0.03
A₂₈₀ / A₂₆₀	0.15 ± 0.02	0.98 ± 0.03	0.66 ± 0.03	0.73 ± 0.02
Concentration	100mM ± 2%	100mM ± 2%	100mM ± 2%	100mM ± 2%
Appearance	Clear Colorless Solution	Clear Colorless Solution	Clear Colorless Solution	Clear Colorless Solution
pH of Solution	7.5	7.5	7.5	7.5
dNTP (HPLC Area)	≥ 99 %	≥ 99 %	≥ 99 %	≥ 99 %
dNDP (HPLC Area)	< 1 %	< 1 %	< 1 %	< 1 %
DNases, RNases, Nicking Activity	Negative	Negative	Negative	Negative
Storage	at -20° C	at -20° C	at -20° C	at -20° C
Stability	≤ 24 months	≤ 24 months	≤ 24 months	≤ 24 month

dNTP set (dA+dC+dG+dT)	100 mM 4 x 250 µl 100 mM 4 x (4 x 250 µl)	PAN739025 PAN739026
------------------------	--	------------------------

Molecular Biology Reagents

dNTP Mix**Features and applications**

- Convenient, pre-optimized and pre-mixed
- Ultra-pure: > 99% tris-phosphate by HPLC
- Extended shelf-life of 24 months at -20° C
- Free from PCR inhibitors
- DNase, RNase and Nickase free

Suitable for a wide variety of applications such as:

- Standard and long range PCR assays
- cDNA synthesis
- qPCR
- Microarrays
- DNA sequencing
- DHPLC
- Labeling

A ready-to-use molecular grade dNTP Mix containing dATP, dCTP, dGTP and dTTP at pH 7.5 as Lithium salts in purified water. The mix is designed to save hands-on time for researchers and minimize the possibility of contamination. For use in DNA polymerization reactions, DNA labeling and sequencing processes. Dependable PCR grade. Lithium salts have greater resistance to repeated freezing and thawing cycles than Sodium salts, and Lithium salt dNTP preparations remain sterile over the entire shelflife due to the bacteriostatic activity of Lithium towards various microorganisms.

dNTP Mix Reaction Guidelines**100 mM Mix contains 25 mM of each dNTP**

Reaction Volume Master Mix Reactions
50 µl 0.5 µl 1000

40 mM Mix contains 10 mM of each dNTP

Reaction Volume Master Mix Reactions
50 µl 1.25 µl 400

This is a guide only, for long-range applications adjust accordingly.

Storage conditions

dNTP Mix can be stored for 24 months at -20° C. Avoid multiple freeze/thaw cycles. For long-term storage, aliquoting is recommended.

Typical analysis

Lithium salts, > 99% deoxynucleoside triphosphates (HPLC, area %), < 1% deoxynucleoside monophosphates and deoxynucleoside diphosphates.

Purity

The dNTPs are > 99% pure by HPLC and are free of DNase, RNase, Protease, phosphatase and nicking activity.

dNTP Mix (dA+dC+dG+dT)	20 µmol 50 µmol	40 mM 100 mM	500 µl 500 µl	PAN739043 PAN739028
------------------------	--------------------	-----------------	------------------	------------------------

Molecular Biology Reagents

Transfection Reagents

NEW !

Transfection is the process of directly introducing naked or purified nucleic acids into eukaryotic cells. The word transfection is a blend of trans- and infection. Genetic material (like supercoiled plasmid DNA or siRNA constructs) or even proteins such as antibodies, may be transfected.

Stable and transient transfection differ in their long term effects on a cell; a stably-transfected cell will constantly express transfected DNA and pass it on to daughter cells, while a transiently-transfected cell will express transfected DNA for a short amount of time and not pass it on to daughter cells.

Transfection of animal cells typically involves opening transient pores or „holes“ in the cell membrane to allow the uptake of material.

There are different kinds of transfection: calcium phosphate, electroporation, cationic lipid with the material to produce liposomes which fuse with the cell membrane and deposit their cargo inside.

Based on cationic lipid PAN-Biotech proved optimised transfection products PANFect A, PANFect A-plus and PANFect siRNA.

PANFect A Transfection Reagent	1.0 ml	P02-8010
PANFect A-plus Transfection Reagent	1.0 ml	P02-8110
PANFect siRNA Transfection Reagent	1.0 ml	P02-8210
PANFect Kit, Transfection Reagent 1-8, Booster 1 & 2 and Buffer Solution	10 x 0.2 ml, 2 x 50 ml	P02-8000K

PANsys 3000

Introduction	149
PANsys 3000	150

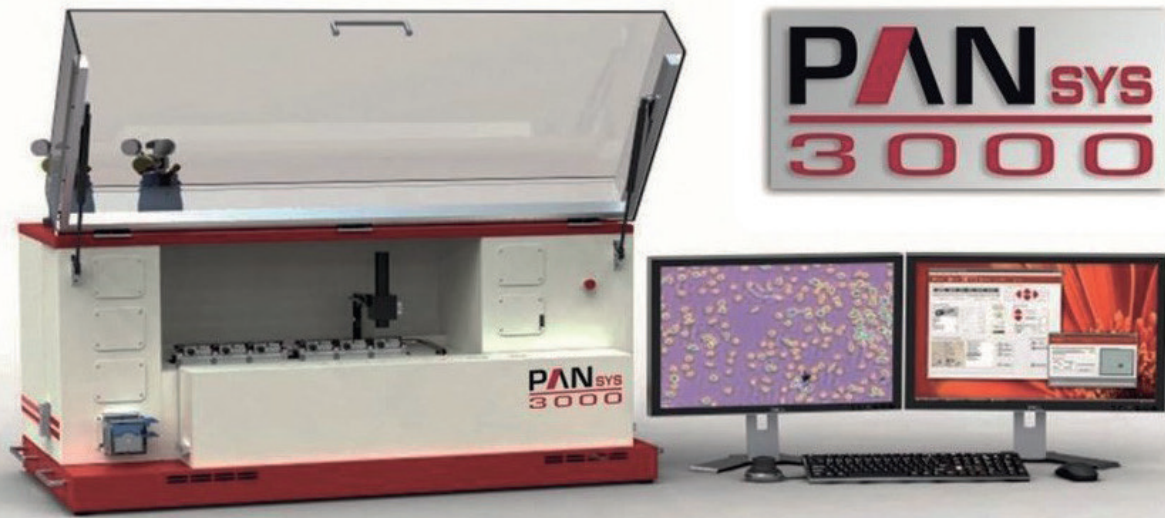

Fully automated cell culture systems

The PANsys 3000 is a highly automated cell culture system that enable a significant reduction in manual processes as well as a complete control and documentation of all important cell culture parameters. Apart from an automated control and supervision of these cell culture parameters, the system offers an integrated and automated evaluation of the cells in culture, determining growth rate, metabolism, and morphology.

The specially developed, patented cell culture chambers are the core of the cell culture units. In the cell culture chambers, cells are automatically supplied with appropriate media according to the selected culture parameters.

The optics with precision control and operation are equipped with a high-resolution CCD microscope (transmitted light, phase contrast and optional 6-channel fluorescence). This microscope records images of freely selectable points in the cell culture according to specified time intervals. These images are automatically saved by software and can be evaluated online. The automated cell-culture system PANsys 3000 is a nearly universally applicable tool for a highly efficient cell culture. Miscellaneous series of tests have proven the suitability of the system for the cultivation of a multitude of cells and cell lines under widely varying conditions.

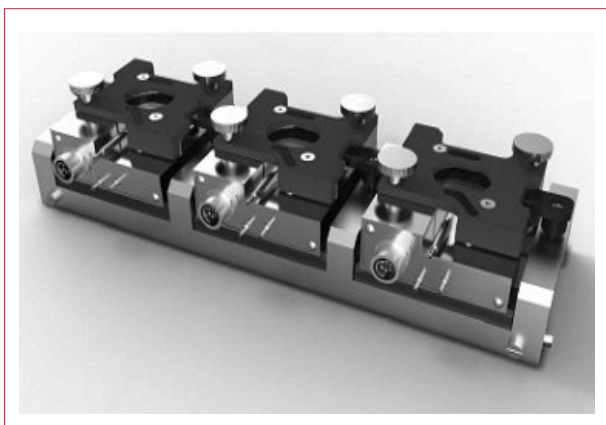

PANsys 3000 features

Closed supply system with automated regulation of all necessary substances (CO₂, O₂, media, nutrients, temperature, activating substances or test drugs).

Automated cell-culture system where various cell types, cell lines and media can be cultivated under controlled conditions.

Up to six separate cell culture chambers (multi-chamber system) with individual equipment of each chamber and automatic adjustment of pre-selected cell culture parameters.

Continuous surveillance and documentation of all relevant cell culture parameters (temperature, CO₂, O₂, pH) with simultaneous microscopic monitoring of cell morphology and growth rate.

Life cell imaging: continuous video-microscopic monitoring of the cells with storage, documentation and analysis. Morphological changes and growth behaviour can be quickly detected and evaluated.

High-level microscopy system with a phase contrast and multi-channel fluorescence microscope for detailed and complex microscopy applications. Individual adaptation of optical characteristics (filters, channels, etc.)

Saving and documentation of all relevant recorded data of cell cultivation, including cell culture parameters and microscope data. Automated evaluation and analysis of all culture parameters and microscope images with powerful, modern software tools.

PANsys 3000

Different PANsys 3000 versions offered**PANsys 3000 Expert**

Expert version with bright-field and phase contrast-microscope, fluidics pumps and incubation-chambers, including software package for system data control and image-analysis

PANsys 3000 Professional

Professional version with bright-field and phase contrast-microscope, optimized fluidics pumps and special chambers for flow-experiments, including software package for system data control and image analysis

PANsys 3000 HighEnd

High-end version with bright-field, phase contrast and 6-channel fluorescence microscope, sophisticated fluidics features, special cell culture chambers, high-end software package for system data control and image analysis

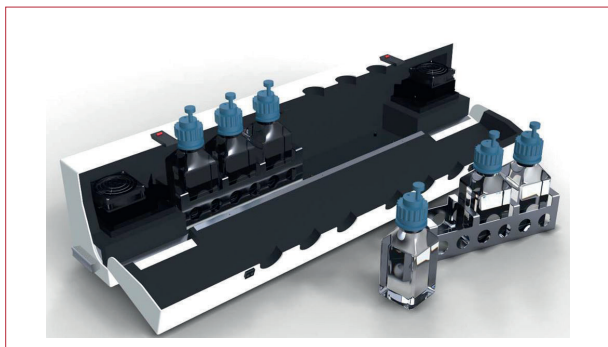
**Areas of application**

- Stem cell research
- Development of serum-free media
- Cloning and differentiation studies
- Optimization of cell culture media
- Investigation of cell-cell interaction
- Drug development and substance screening
- Tissue cultivation and tissue engineering
- Cell cycle analysis
- Cellular cytotoxicity tests to reduce animal testing
- Endothelial flow experiments with shear-stress
- Simulation and optimization of production processes
- Customized applications

PANsys 3000 offers unique and extraordinary possibilities for in vitro cultivation and research on the most diverse cell lines under in vivo-like conditions. It reduces the gap between in vitro and in vivo applications through a powerful cell culture and life-cell imaging system with easy operability. PANsys 3000 enables the design of complex, artificial organ models, in order to determine specific cell behaviour and influencing factors, environmental conditions, or activating substances. PANsys 3000 improves developmental quality through the vastly detailed analysis and documentation of all data related to cell culture, including microscopic imaging. PANsys 3000 reduces your development costs through automation and a significant reduction of manual processes with much less resource consumption. PANsys 3000 reduces your development times through a parallelization of cell culture processes.

Single-Use 2D-Bag production

NEW!

Introduction

PAN Biotech offers a broad portfolio of liquid media in 2D bags. The range includes both PAN Biotech media and customer formulations. The single-use bags we use are specially designed for use in biotechnology and diagnostics.

The layer contacting the product of our 2D Single-Use bags consists of ethyl vinyl acetate (EVA).

Specifications of 2D-Bags

- BSE-TSE status: Raw materials compliant with European Guideline EMA / 410/01
- Classified as fluid path USP Class VI
- Sterilized to AAMI TIR33 with 10⁶
- 6 Sterility Assurance Level (SAL) Gamma

After sterile filling of the media the bags are placed in two low-germ outer packagings. Having passed the Quality Assurance the goods are ready for immediate shipping to the customer.

Sizes

The standard sizes of our 2D Single-Use bags are:

1 L, 5 L, 10 L, 20 L and 50 L

Depending on the customer requirements, the products are filled sterile especially for the customer.

Connections / Couplings

PAN-Biotech offers many different connectivity options and extensions that are tailored to your application. You can choose from 80 different connection options (e.g.: MPC male / female coupling, or a Y-adapter to simultaneously pump the contents of two different bags into a reactor with the correct coupling / tubing system). The connections / couplings are packed low-germ and autoclaved. The sterile adapters / couplings can be connected directly to your filled bag. Thus, you can start directly with your procedure via Plug-and-Use-System (PnU).

- MPC / MPX
- Quick-Connect Adapter
- Clutch distribution
- Back-to-back body adapters
- Sanitary Series
- and many more...

Extensions / Tubes

We offer 2 extension options as a standard feature with the following tubes:

- Silicone
- C-Flex
- others on request

The range of application varies from customer to customer, therefore PAN-Biotech offers to provide the bags individually with couplings and tubes. The tubes, like the connections / couplings, are packed low-germ and are autoclaved afterwards. To complete our service, an inhouse shipping service is available to deliver the filled bags to your site just-in-time. With our plug-and-use system (PnU) you can start directly with the application.

In cooperation with you, we are happy to plan a complete change from bottles to a closed, future-proof single-use-bag system. Contact us! We are happy to help you anytime!

More information can also be found at www.pan-biotech.com.

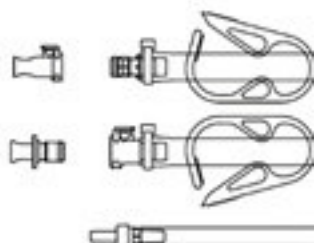
Standard Connections

Port 1: MPC Male

Port 2: MPC Female

Port 3: Injection Site



Single-Use 3D-Bag

NEW !

Introduction

PAN Biotech offers a broad portfolio of liquid media in 3D bags. The range includes both PAN Biotech media and customer formulations. The single-use bags we use are specially designed for use in biotechnology and diagnostics.

The layer contacting the product of our 3D Single-Use bags consists of ethyl vinyl acetate (EVA).

Specifications of 3D-Bags

- BSE-TSE status: Raw materials compliant with European Guideline EMA / 410/01
- Classified as fluid path USP Class VI
- Sterilized to AAMI TIR33 with 10⁶
- 6 Sterility Assurance Level (SAL) Gamma

The bag systems are safely packed after sterile filling and provided after successful quality control for immediate use by the customer. The 3D bags are suitable for larger quantities of liquids (over 100 liters). The filled bags are optimally adapted to the intended containers made of plastic or metal. The delivery takes place in a special plastic container which has optimal features for further storage.

Sizes

The standard sizes of our 3D Single-Use bags are: 100 L, 200 L, 500 L and 1000 L.

Depending on the customer requirements, the products are filled sterile especially for the customer.

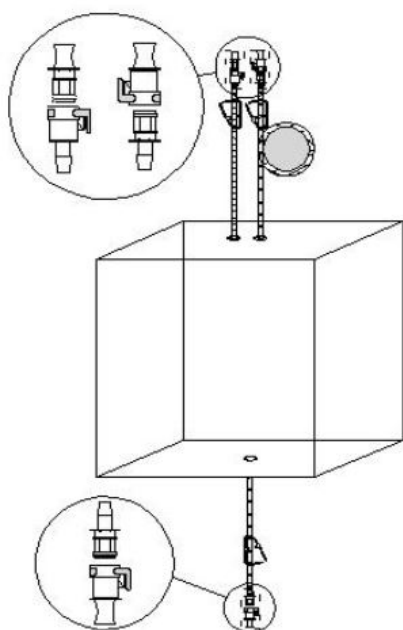

Standard connections:
 Port 1: MPX Male + Cap, Pinch Clamp
 Port 2: MPX Female + Cap, Pinch Clamp
 Port 3: MPX Male + Cap, Pinch Clamp

Connections / Couplings

PAN-Biotech offers many different connectivity options and extensions that are tailored to your application. You can choose from 80 different connection options (e.g.: MPX male / female coupling, or other different Y-adapter). The connections / couplings are packed low-germ and autoclaved. The sterile adapters / couplings can be connected directly to your filled bag. Thus, you can start directly with your procedure via Plug-and-Use-System (PnU).

- MPC / MPX
- Quick-Connect Adapter
- Clutch distribution
- Back-to-back body adapters
- Sanitary Series
- and many more...

Extensions / Tubes

We offer 2 extension options as a standard feature with the following tubes:

- Silicone
- C-Flex
- others on request

The range of application varies from customer to customer, therefore PAN-Biotech offers to provide the bags individually with couplings and tubes. The tubes, like the connections / couplings, are packed low-germ and are autoclaved afterwards. To complete our service, an inhouse shipping service is available to deliver the filled bags to your site just-in-time. With our plug-and-use system (PnU) you can start directly with the application.

More information can also be found at www.pan-biotech.com.



Alphabetical Product Index

Product	Page	Product	Page
A		E	
Accumax	120	Earl` s Buffered Salt Solution	111
Accutase	119	EBSS	111
Agarose	144	EDTA	121
Albumin, bovine	127	EMEM Fibroblast Medium	105
Albumin, human	127	Endopan 3	102
Alpha MEM	62	Endopan 300 SL	45
Amino Acids	116	Endopan MV	102
Amniopan	106	Endopan PRO	103
Amniopan S2	106	Enzymes for Cell Dissociation	119
Amniopan III	106	Erythrolyse Buffer	114
Amphotericin B	117		
Animal Sera	15	F	
Antibiotics	117	Fetal Bovine Serum	10
Antifungal Drugs	117	Fetal Bovine Serum Biotech	12
Attachment Factors	122	FBS Good	14
		FBS Good Forte	14
B		FBS MSC	11
Bacitracin	117	Fetal Bovine Serum Premium	10
Biologicals	128	Fetal Bovine Serum Standard	10
BME Amino Acids Solution	116	Fetal Bovine Serum Supreme	10
BME Vitamin Solution	116	Fibronectin	123
BME with Earle` s Salts	64	Freezing Medium	126
BME with Hank` s Salts	64		
Bovine Serum	15	G	
Bovine Serum Albumin	127	GBSS	113
β -Mercapthoethanol	110	Gelatine Solution	122
		Gentamicin sulfate	117
C		Gey` s Balanced Salt Solution	113
Calf serum	15	Glasgow MEM (BHK 21)	74
Chicken serum	15	GMEM	74
CMRL-1066 Medium	65	Goat serum	15
Collagen A	122	Grace` s Insect Medium	75
Collagen R	122	Growth Factors	130
Collagenase	119		
Cryopan I	126	H	
Cryo Preservation	126	Ham` s F10 Medium	76
		Ham` s F12 Medium	77
D		Hank` s Balanced Salt Solution	112
Demecolcine Solution	110	HBSS	112
Dimethylsulfoxide	126	HAT supplement	110
Dispase	121	HEPES buffer	110
DMEM	66	HEPES	110
DMEM/F12	72	Horse serum	15
DMSO	126	hPL	23
dNTP Mix	146	HT supplement	110
dNTP Sets	145	Human Cytokines	130
Donkey serum	15	Human Platelet Lysate	23
Dulbecco` s Modified Eagle Medium	66	Human Serum	20
Dulbecco` s Phosphate Buffered Salt Solution	111	Human Serum Albumin	127
		Human Transferrin apo	110
		Hygromycin B	117

Alphabetical Product Index

Product	Page	Product	Page
I		P	
IMDM	79	Paneticin G418	118
Insulin human	110	Panexin basic	28
IPL-41 Insect Medium	82	Panexin BMM	31
Iscove`s Modified Dulbecco`s Medium	79	Panexin NTA	29
ITS Solution	110	Panexin NTS	30
J		PANFect A	147
Joklik-MEM	83	PANFect A-plus	147
K		PANFect siRNA	147
Kanamycin sulfate	117	PANScript DNA Polymerase	137
L		PANScript red DNA Polymerase	138
Lamb serum	15	Pansera ES	11
Laminin Mouse	123	Panserin 293A	38
Leibovitz`s L-15 Medium	84	Panserin 293S	38
L-Glutamine	116	Panserin 401	32
M		Panserin 411	33
Marrowpan	107	Panserin 411S	33
Marrowpan S2	107	Panserin 412	34
McCoy`s 5A Medium	86	Panserin 413, modified	34
MCDB 131 Medium	88	Panserin 416	34
Media Supplements	110	Panserin 701	40
Medium 199 with Earle`s Salts	89	Panserin 802	40
Medium 199 with Hank`s Salts	90	Panserin C6000	37
MEM Amino Acids Solution	116	Panserin H4000	35
MEM Vitamin Solution	116	Panserin H8000	36
MEM with Earle`s Salts	91	Panserin ProVero	39
MEM with Hank`s Salts	93	Panserin PX10	41
β -Mercapthoethanol	110	Panserin PX40	42
Mesenpan	105	Panserin S2	44
Minocyclin	117	Panserin T3	39
Molecular Biology	134	PANsys 3000	148
Mouse serum	15	Pantum	104
Mycorase	117	Penicillin	118
N		Pig serum	15
Neomycin sulfate	117	Pluronic	110
Neuropan	104	Polymerases	136
Nystatin Solution	117	Polymyxin B sulfate	118
P		PowerScript DNA Polymerase Long Range	141
PAN DNA Clean	143	PowerScript DNA Polymerase Short Range	140
PAN Hot Start DNA Polymerase	139	PowerStem ESPro1	49
PAN Ladder I	142	PowerStem ESPro2	50
Pancoll	124	PowerStem EST	51
Paneticin 420	118	PowerStem HE1	52
		PowerStem HE2	53
		PowerStem HPSC	57
		PowerStem iPS1	54
		PowerStem iPS2	55
		PowerStem MSC1	56
		PowerStem PEC1	58
		PowerStem PEC1 kit	58
		Proteinase K	142
		Puck`s Salt Solution A	113

Alphabetical Product Index

Product	Page
R	
Rabbit serum	15
Rat serum	15
RPMI 1640	94
S	
Schneider`s Drosophila Medium	97
Separating Solutions	124
Separating Solutions Pre-Filled	125
Seraclot	22
Sera Low	10
Sheep serum	15
Single-Use 2D-Bag	152
Single-Use 3D-Bag	153
Sodium bicarbonate	110
Sodium Chloride Solution	110
Sodium pyruvate	110
Spodopan	43
Stempan	105
Sterile Water	110
Streptomycin	118
T	
TC 100 Insect Medium	98
Tiamulin	118
TNM-FH Medium	99
Transfection Reagents	147
Tyrode`s Salt Solution	113
Trypsin	121
V	
Vitamins	116
W	
Waymouth`s MB 752/1 Medium	100
William`s Medium E	101

Numeric Product Index

Product No.	Page	Product No.	Page	Product No.	Page	Product No.	Page
2705005	123	CB-1117007	133	CB-2230030	133	P02-8010	147
2705001S	123	CB-1117008	133	CB-2230031	133	P02-8110	147
CB-11000050	133	CB-1119000	130	CB-2230111	133	P02-8210	147
CB-1101001	130	CB-1119001	130	CB-2230120	133	P03-0010	66
CB-1101002	130	CB-1125032	131	CB-2230121	133	P03-0050	66
CB-1101003	130	CB-1127000	132	CB-2230220	133	P03-01510	66
CB-1102010	130	CB-1127100	132	CB-2230221	133	P03-01550	66
CB-1102011	130	CB-1210000	133	CB-2230300	133	P03-02010P	83
CB-1102021	130	CB-1212011	133	CB-2230301	133	P03-02050P	83
CB-1102023	130	CB-1212011M	133	CB-2230302	133	P03-0510	66
CB-1102024	130	CB-1214000	133	CB-2230403	133	P03-0550	66
CB-1104113	130	CB-1214001	133	CB-2230600	133	P03-0710	69
CB-1104201	130	CB-1214120	133	CB-2230601	133	P03-0750	69
CB-1104202	130	CB-1214121	133	CB-2230602	133	P03-0810	69
CB-1105001	131	CB-1300058	131	CB-2231202	133	P03-0850	69
CB-1106001	131	CB-1300118	132	CB-2250001	133	P03-0910	69
CB-1108002	130	CB-1412011	133	CB-2310015	133	P03-0950	69
CB-1108003	130	CB-1515001	130	CB-2310016	133	P03-1010	69
CB-1108010	130	CB-2015001	130	CB-2420031	133	P03-1050	69
CB-1108011	130	CB-2110000	130	CB-2420032	133	P03-1110	72
CB-1108100	130	CB-2110003	130	CB-2800001	130	P03-1150	72
CB-1109200	132	CB-2110005	130	CB-2800002	130	P03-1210	72
CB-1109201	132	CB-2110100	130	CB-2800007	130	P03-1250	72
CB-1109301	132	CB-2110101	130	CB-2800008	130	P03-1310	80
CB-1110000	132	CB-2120100	131	CB-2800010	130	P03-1350	80
CB-1110001	132	CB-2120101	131	CB-2800011	130	P03-1410	80
CB-1110002	132	CB-2120110	131	CB-3410010	132	P03-1450	80
CB-1111122	132	CB-2120112	131	CB-3410011	132	P03-1510	84
CB-1111131	132	CB-2120121	131	CB-4070010	131	P03-1550	84
CB-1111151	132	CB-2130120	131	LS0002100	121	P03-1610	84
CB-1111153	132	CB-2130121	131	LS0004174	119	P03-1650	84
CB-1111162	132	CB-2130123	131	LS0004176	119	P03-1710	86
CB-1112011	132	CB-2130202	131	LS0004180	119	P03-1750	86
CB-1112012	132	CB-2130203	131	LS0004182	119	P03-1810	86
CB-1113008	130	CB-2130300	131	LS0004186	119	P03-1850	86
CB-1113011	130	CB-2130301	131	LS0004188	119	P03-1910	89
CB-1113012	130	CB-2130405	131	LS0004194	119	P03-1950	89
CB-1114002	132	CB-2130407	131	LS0004196	119	P03-2110	90
CB-1114011	132	CB-2130501	131	MB-1100500	137	P03-2150	90
CB-1114013	132	CB-2130600	131	MB-1100600	138	P03-2310	63
CB-1114100	132	CB-2130603	131	MB-1120250	141	P03-2350	63
CB-1114102	132	CB-2131000	131	MB-1120500	141	P03-2410	63
CB-1115000	130	CB-2131001	131	MB-1860250	139	P03-2450	63
CB-1115001	130	CB-2131201	131	MB-1860500	139	P03-2510	63
CB-1115002	130	CB-2131500	131	MB-1865000	139	P03-2550	63
CB-1115006	130	CB-2131501	131	MB-30010250	136	P03-2610	63
CB-1116001	130	CB-2210000	133	MB-30020250	136	P03-2650	63
CB-1117001	131	CB-2210001	133	MB-4300002	142	P03-2710	92
CB-1117001M	131	CB-2210002	133	P02-8000K	147	P03-2750	92

Numeric Product Index

Product No.	Page	Product No.	Page	Product No.	Page	Product No.	Page
P03-2810	92	P03-9050	75	P04-03556	67	P04-14559	77
P03-2850	92	P03-9110	75	P04-03560	68	P04-15500	77
P03-2910	92	P03-9150	75	P04-03588	68	P04-15600	77
P03-2950	92	P03-9210	82	P04-03590	67	P04-16151	94
P03-3010	92	P03-9250	82	P04-03591	67	P04-16500	95
P03-3050	92	P03-9310	97	P04-03596	67	P04-16515	95
P03-3110	74	P03-9350	97	P04-03598	68	P04-16516	94
P03-3150	74	P03-9610	98	P04-03600	67	P04-16520	96
P03-3310	93	P03-9650	98	P04-04057	68	P04-16530	96
P03-3350	93	P03-9710	99	P04-04500	67	P04-16598	95
P03-3910	76	P03-9750	99	P04-04510	67	P04-17500	94
P03-3950	76	P04-00024	104	P04-04550	68	P04-17510	94
P03-4010	76	P04-00064	104	P04-05050	86	P04-17545	95
P03-4050	76	P04-00100	102	P04-05500	86	P04-17546	96
P03-4110	77	P04-0010K	102	P04-05540	68	P04-17550	94
P03-4150	77	P04-00200	102	P04-05545	68	P04-17598	95
P03-4310	95	P04-0020K	102	P04-05550	68	P04-17599	94
P03-4350	95	P04-00386	104	P04-05551	66	P04-17850	94
P03-4410	95	P04-00507	91	P04-05610	86	P04-18000	94
P03-4450	95	P04-00508	92	P04-06500	86	P04-18047	95
P03-4510	100	P04-00509	92	P04-07050	89	P04-18050	96
P03-4550	100	P04-00586	104	P04-07150	89	P04-18500	96
P03-4810	101	P04-0065K	45	P04-07250	89	P04-19500	94
P03-4850	101	P04-00700	103	P04-07450	90	P04-19550	95
P03-5010	76	P04-0070K	103	P04-07500	89	P04-20050	79
P03-5050	76	P04-00900	104	P04-07600	90	P04-20150	79
P03-5210	80	P04-01158	67	P04-07753	90	P04-20150S2	80
P03-5250	80	P04-01159	66	P04-08049	105	P04-20250	79
P03-6010	72	P04-01161	67	P04-08050	91	P04-20259	80
P03-6050	72	P04-01163	68	P04-08056	92	P04-20350	79
P03-6110	72	P04-01500	66	P04-08150	91	P04-20351	80
P03-6150	72	P04-01501	67	P04-08250	92	P04-20450	79
P03-6510	69	P04-01504	67	P04-08500	92	P04-20451	80
P03-6550	69	P04-01515	66	P04-08509	91	P04-20451S1	80
P03-6810	74	P04-01516	67	P04-08510	92	P04-21049	94
P03-6850	74	P04-01548	66	P04-08549	92	P04-21050	62
P03-6910	74	P04-01548S1	66	P04-09050	91	P04-21051	62
P03-6950	74	P04-01549	66	P04-09500	92	P04-21060	62
P03-7210	95	P04-01550	66	P04-10050	93	P04-21150	62
P03-7250	95	P04-01551	66	P04-10500	93	P04-21200	83
P03-7310	95	P04-01555	67	P04-10599	93	P04-21250	62
P03-7350	95	P04-01597	68	P04-12049	76	P04-21300	83
P03-7410	91	P04-02500	66	P04-12050	76	P04-21350	62
P03-7450	91	P04-02500S1	66	P04-12500	76	P04-21500	62
P03-7610	95	P04-02501	67	P04-13050	76	P04-21502	62
P03-7650	95	P04-03500	67	P04-13500	76	P04-22100	95
P03-7710	95	P04-03503	68	P04-14500	77	P04-22500	94
P03-7750	95	P04-03550	67	P04-14501	77	P04-25050	64
P03-9010	75	P04-03551	68	P04-14550	77	P04-25500	64

Numeric Product Index

Product No.	Page	Product No.	Page	Product No.	Page	Product No.	Page
P04-26050	64	P04-43100	110	P04-710416	34	P04-84500	65
P04-27050	84	P04-44100	110	P04-710608	38	P04-84600	65
P04-27054	84	P04-47500	111	P04-710608M	38	P04-850100	43
P04-27055	84	P04-48010P	113	P04-710609	38	P04-850500	43
P04-27500	84	P04-48050P	113	P04-710609M	38	P04-85600	82
P04-28500	100	P04-48500	113	P04-710613	39	P04-90500	97
P04-29050	101	P04-49100	112	P04-710701	40	P04-91500	97
P04-29050S1	101	P04-49105	112	P04-710701M	40	P04-92500	98
P04-29150	101	P04-49500	112	P04-710802K	40	P04-93500	98
P04-29500	101	P04-49505	112	P04-710PX10	41	P04-951SA2	31
P04-29510	101	P04-50100	112	P04-710PX40	42	P04-95700	29
P04-30010P	111	P04-50105	112	P04-714000	35	P04-95750	29
P04-30050P	111	P04-50500	112	P04-714000M	35	P04-95800	30
P04-30500	111	P04-50505	112	P04-71411S	33	P04-95850	30
P04-31500	111	P04-51100	113	P04-71413	34	P04-96500	74
P04-32010P	112	P04-51500	113	P04-716000	37	P04-96900	28
P04-32050P	112	P04-53500	111	P04-716000M	37	P04-96950	28
P04-32100	112	P04-54010P	113	P04-718000	36	P04-97500	74
P04-32105	112	P04-54050P	113	P04-718000M	36	P04-98500	74
P04-32500	112	P04-54500	113	P04-7411S0	33	P04-991000	110
P04-32505	112	P04-60100	124	P04-7411S1	33	P04-991500	110
P04-33010P	112	P04-60110	124	P04-77010K	49	P04-992000	110
P04-33050P	112	P04-60125	125	P04-77020K	50	P05-01100	110
P04-33100	112	P04-60150	124	P04-77110K	52	P05-01100P	110
P04-33500	112	P04-60225	125	P04-77120K	53	P05-01500	110
P04-34100	112	P04-60500	124	P04-77130K	54	P05-01500P	110
P04-341000	112	P04-63100	124	P04-77140K	55	P05-39500	110
P04-34500	112	P04-63225	125	P04-77250K	51	P06-01001	117
P04-35500	111	P04-63500	124	P04-77355K	56	P06-01005	117
P04-360000	111	P04-64100	124	P04-77450K	57	P06-01050	117
P04-360010B	111	P04-64500	124	P04-77510K	49	P06-01050P	117
P04-36050P	111	P04-65100	124	P04-77620K	50	P06-01100	117
P04-361000	111	P04-65500	124	P04-777500	58	P06-01100P	117
P04-362500	111	P04-67100	124	P04-77750K	58	P06-01225P	117
P04-3625C	111	P04-67500	124	P04-80025P	116	P06-01250P	117
P04-36500	111	P04-68100	124	P04-80050	116	P06-02010P	117
P04-3650C	111	P04-68500	124	P04-80053	88	P06-02025P	117
P04-37500	111	P04-70100	106	P04-80054	88	P06-02100	118
P04-38500	111	P04-70101	106	P04-80057	88	P06-03001	117
P04-39500	111	P04-70103	106	P04-80100	116	P06-03001P	117
P04-41150	73	P04-70200	107	P04-80100P	116	P06-03005	117
P04-41151	73	P04-70201	107	P04-80500	99	P06-03010P	117
P04-41250	73	P04-710100	39	P04-80500P	116	P06-03025P	117
P04-41251	73	P04-710200	44	P04-81500	75	P06-03050	117
P04-41252	73	P04-710210	44	P04-82010P	116	P06-03100	117
P04-41450	73	P04-710401	32	P04-82050	116	P06-04001	117
P04-41500	73	P04-710401M	32	P04-82100	116	P06-04005	117
P04-41550	73	P04-710411	33	P04-82500	75	P06-04010P	117
P04-41650	73	P04-710412	34	P04-83500	99	P06-04050	117

Numeric Product Index

Product No.	Page	Product No.	Page	Product No.	Page	Product No.	Page
P06-04050P	117	P06-139310	127	P07-07200	104	P10-21100	119
P06-04100	117	P06-139350	127	P07-07210	104	P10-21200	120
P06-05050	117	P06-139410	127	P07-11010	104	P10-21250	120
P06-05100	117	P06-139450	127	P07-11100	104	P10-21500	119
P06-06010P	117	P06-14001	117	P07-20001	104	P10-90100	114
P06-06025P	117	P06-14005	117	P07-20021	104	P10-90500	114
P06-06050	117	P06-14050	117	P07-90050	126	P-2060020	131
P06-06100	117	P06-14100	117	P07-91010	110	P-2060100	131
P06-06100P	117	P06-15001	117	P07-92010	126	P-2360011	131
P06-07001	118	P06-15005	117	P07-92050	126	P-2360012	131
P06-07005	118	P06-15050	117	P08-02100	110	P-2360013	131
P06-07050	118	P06-15100	117	P08-2000	116	P-2701001	130
P06-07100	118	P06-16001P	118	P08-30100	116	P-2701002	130
P06-07300	118	P06-16005P	118	P08-31100	116	P30-0101	15
P06-07301	118	P06-16010P	118	P08-32100	116	P30-0102	15
P06-07305	118	P06-16020	118	P08-40100	116	P30-01901	15
P06-07350	118	P06-16100	118	P08-41100	116	P30-01901E	15
P06-07800	117	P06-16220	118	P08-50400K	105	P30-0200	15
P06-080050P	117	P06-20020	122	P08-50500	105	P30-0201	15
P06-080100P	117	P06-20030	122	P08-50600	105	P30-0301	15
P06-08020	117	P06-20100	122	P10-019100	121	P30-0302	15
P06-08025P	118	P06-20166	122	P10-019500	121	P30-0401	15
P06-08100	117	P06-20410	122	P10-020100	121	P30-0402	15
P06-08100P	118	P06-20501	123	P10-020500	121	P30-0601	15
P06-09050	118	P06-21000	110	P10-021100	121	P30-0602	15
P06-11025P	118	P06-21100	110	P10-021500	121	P30-0701	15
P06-11050P	118	P06-21500	110	P10-022100	121	P30-0702	15
P06-11100P	118	P06-25200	122	P10-022500	121	P30-0801	15
P06-12001	118	P06-26025	127	P10-023100	121	P30-0802	15
P06-12005	118	P06-26050	127	P10-0231SP	121	P30-0901	15
P06-12050	118	P06-26150	127	P10-023500	121	P30-0902	15
P06-12100	118	P06-261100	127	P10-0235SP	121	P30-1001	15
P06-13001	117	P06-27020	127	P10-024100	121	P30-1002	15
P06-13005	117	P06-27100	127	P10-024500	121	P30-1101	15
P06-13050	117	P06-27500	127	P10-025025P	121	P30-1102	15
P06-13100	117	P07-01100	110	P10-025100P	121	P30-1301	10
P06-138110	127	P07-02100	110	P10-025500P	121	P30-1302	10
P06-138150	127	P07-03100	110	P10-026100	121	P30-1305	10
P06-138210	127	P07-03110	110	P10-026500	121	P30-1306	10
P06-138250	127	P07-03200	110	P10-027100	121	P30-1401	10
P06-138310	127	P07-03210	110	P10-027500	121	P30-1402	10
P06-138350	127	P07-03400	110	P10-028100	121	P30-1405	10
P06-138410	127	P07-03410	110	P10-029100	121	P30-1406	10
P06-138450	127	P07-04200	110	P10-029500	121	P30-2401	22
P06-1391050	127	P07-04300	110	P10-032100	121	P30-2402	22
P06-1391100	127	P07-05020	110	P10-033100	121	P30-2501	22
P06-1391500	127	P07-05100	110	P10-040100	121	P30-2502	22
P06-139210	127	P07-07010	104	P10-040500	121	P30-2601	11
P06-139250	127	P07-07100	104	P10-100100	121	P30-2602	11

Numeric Product Index

Product No.	Page	Product No.	Page	Product No.	Page	Product No.	Page
P30-2605	11	P-4390010	133				
P30-2606	11	P60-15840100	126				
P30-2608	11	P60-36720100	126				
P30-2609	11	PAN721064	140				
P30-2611	11	PAN721065	140				
P30-2612	11	PAN733025	142				
P30-2701	22	PAN733026	142				
P30-2702	22	PAN737042	143				
P30-2901	22	PAN737046	143				
P30-2902	22	PAN739025	145				
P30-3030	10	PAN739026	145				
P30-3031	10	PAN739028	146				
P30-3301	10	PAN739043	146				
P30-3302	10	PAN741025	144				
P30-3305	10	PANsys3000	148				
P30-3306	10						
P30-4101	15						
P30-4102	15						
P30-5100	10						
P30-5500	10						
P-3610002	130						
P-3860001	133						
P-3860002	133						
P40-1301	12						
P40-1302	12						
P40-1401	12						
P40-1402	12						
P40-2701	22						
P40-2702	22						
P40-29020	23						
P40-29050	23						
P40-29100	23						
P40-3001	22						
P40-3002	22						
P40-3011	22						
P40-3012	22						
P40-37100	14						
P40-37500	14						
P40-38100	14						
P40-38500	14						
P40-39100	14						
P40-39500	14						
P40-47100	14						
P40-47500	14						
P40-48100	14						
P40-48500	14						
P40-49100	14						
P40-49500	14						
P-4390002	133						



www.pan-biotech.de

PAN-Biotech GmbH
Am Gewerbepark 13
D-94501 Aidenbach
GERMANY

Phone: +49 (0)8543/6016-30
Fax: +49 (0)8543/6016-49

www.pan-biotech.de
www.pan-biotech.com

Edition 2018/2019

